



---

# INDUSTRIAL HOSE

---

CATALOG

[TEXCELINDUSTRIAL.COM](http://TEXCELINDUSTRIAL.COM)





# MAKING A DIFFERENCE FOR YOUR BUSINESS

Our expansive line of industrial hose and fittings is not just a product division. It's a promise of superior service, quality, technical support and availability. We've built our company on impeccable customer service. Let us know how we can make a difference for your business.



## CUT-TO-LENGTH HOSES

Save money on unwanted hose inventories by ordering the exact amount of product you need. Look for our cut-to-length icon in this catalog.



## 24-HOUR RESPONSE TEAM

Whether you have an emergency or simply need dependable products quickly, our team is available around the clock to make sure you receive the products and services you need.



## LARGE INVENTORY

We keep deep product inventories, which are strategically located at our regional warehouses, so you will always have the product you need, when you need it most.



# TABLE OF CONTENTS



## PETROLEUM

<b>GAMMA™ - 10K MUD &amp; CEMENTING HOSE</b> , 10,000 PSI Hose	08
<b>GAMMA™ - SLIM HOLE ROTARY HOSE</b> , 4,000 PSI Hose	09
<b>SUPRA™ - HPOJ</b> , High Pressure Oil & Jetting Hose	10
<b>TEX-FUEL</b> , Fuel Transfer Hose	11
<b>TEX-F.O.D.</b> , Fuel Oil Delivery Hose	12
<b>HBR4</b> , Low Pressure Suction/Return Hose	13
<b>TEX-OVAC</b> , Oilfield Suction Hose	14
<b>GAMMA™-FLEX OVAC</b> , Corrugated Oilfield Suction Hose	15
<b>TEX-FRAC</b> , Frac Tank Hose	16
<b>TEX-FRAC ASSEMBLY</b> , Frac Tank Hose Assembly	17
<b>TEX-OIL-D</b> , 200psi Oil Discharge Hose	18
<b>GAMMA™-RED OIL</b> , Oil Delivery Hose	19
<b>GAMMA™-BLEND</b> , 400psi Blender/Fracturing Hose	20
<b>GAMMA™-MULTI OIL</b> , 500psi Multi-Purpose Discharge Hose	21
<b>GAMMA™-RED TANK</b> , Red Tank Truck Hose	22
<b>GAMMA™-FLEX RED TANK</b> , Red Corrugated Tank Truck Hose	23
<b>GAMMA™-TANK</b> , Tank Truck Hose	24
<b>GAMMA™-FLEX TANK</b> , Corrugated Tank Truck Hose	25
<b>GAMMA™-TANK 300</b> , 300psi Heavy-Duty Tank Truck Hose	26
<b>GAMMA™-FLEX TANK 300</b> , 300psi Heavy-Duty Corrugated Tank Truck Hose	27
<b>GAMMA™-FLEX TANK 500</b> , 500psi Heavy-Duty Corrugated Tank Truck Hose	28
<b>TEX-OSD 250</b> , 250psi Oil Suction & Discharge Hose	29
<b>TEX-OBL</b> , Built-In Flanges Oil Suction & Discharge Assemblies	30
<b>SIGMA-TDG™</b> , Tank Drop Hose	31
<b>SIGMA-TDHD™</b> , Heavy-Duty Tank Drop Hose	32
<b>SIGMA-TD 150™</b> , 150psi Heavy-Duty Tank Drop Hose	33
<b>SIGMA-VRM™</b> , Medium-Duty Yellow Vapor Recovery Hose	34
<b>SIGMA-VRH™</b> , Heavy-Duty Red Vapor Recovery Hose	35
<b>SIGMA-BANDING SLEEVES™</b>	36



## WATER

<b>GAMMA™ JETT</b> , Water Jetting Hose	38
<b>SIGMA-HD GREEN PVC™</b> , Heavy-Duty Green PVC Water Suction Hose	39
<b>SIGMA-HD CLEAR PVC™</b> , Heavy-Duty Clear PVC Water Suction Hose	40
<b>SIGMA-PB DISCHARGE™</b> , Blue PVC Lay-Flat Discharge Hose	41
<b>SIGMA-PB DISCHARGE™</b> , Blue PVC Lay-Flat Discharge Hose Coupled	42
<b>SIGMA-RH DISCHARGE™</b> , Heavy-Duty Red PVC Lay-Flat Discharge Hose	43
<b>SIGMA-RH DISCHARGE™</b> , Heavy-Duty Red PVC Lay-Flat Discharge Hose Coupled	44
<b>TEX-MILL</b> , Mill Discharge Hose (Single Jacket)	45
<b>SIGMA-PVC AQUA™</b> , PVC Water Suction Hose	46
<b>SIGMA-CLAMP™</b> , Double Bolt Spiral Clamp	47
<b>TEX-AQUA HD</b> , Heavy-Duty Water Suction & Discharge Hose	48
<b>TEX-FLO 2MD</b> , Medium-Duty 2-Ply Water Discharge Hose	49
<b>TEX-FLO 4HD</b> , Heavy-Duty 4-Ply Water Discharge Hose	50

## CHEMICAL

<b>GAMMA™-FLEX XLPE</b> , Cross-Linked Polyethylene Chemical Hose	52
<b>GAMMA™-FLEX UHMW</b> , Ultra-High Molecular Weight Polyethylene Chemical Hose	53

## AIR

<b>TEX-PUSH-ON 300</b> , 300psi Push-On Hose	56
<b>TEX-MP</b> , Multi-Purpose Air Hose	57
<b>TEX-MP MAX</b> , Multi-Purpose Air Hose	58
<b>TEX-CONTRACTORS</b> , Banded Contractor's Assembly	59
<b>TEX-CRIMP CONTRACTORS</b> , Crimped Contractor's Assembly	60
<b>TEX-MASTER</b> , Heavy-Duty Textile Reinforced Air Hose	61
<b>TEX-KING</b> , Wire Air Hose	62
<b>TEX-STEAM</b> , Steam Hose	63
<b>TEX-GS</b> , General Service Air & Water Hose	64

## MATERIAL HANDLING

<b>SIGMA-POLY-U™</b> , Lightweight Polyurethane Hose	65
<b>SIGMA-ULTRAVAC-SBR™</b> , SBR Vacuum Hose	66
<b>SIGMA-ULTRAVAC™</b> , Polyurethane Vacuum Hose	67
<b>SIGMA-URE-B™</b> , Polyurethane Material Handling Hose with PVC Cover	68
<b>SIGMA-URE HD BLUE™</b> , Heavy-Duty Polyurethane Material Handling Hose	69
<b>GAMMA™-HTA</b> , Hot Tar and Asphalt Hose	70
<b>GAMMA™-HEAT</b> , Hot Air Blower Hose	71
<b>GAMMA™-BULK</b> , Dry Bulk Material Discharge Hose	72
<b>TEX-BLAST</b> , Sandblast Hose	73
<b>GAMMA™-COMM DISCHARGE</b> , Commodity Discharge Hose	74
<b>GAMMA™-BLACK COMM</b> , Black Commodity Suction Hose	75
<b>TEX-COMMODITY</b> , FDA Commodity Hose	76
<b>TEX-ELEPHANT</b> , Elephant Trunk Hose	77
<b>TEX-DREDGE</b> , Dredge Sleeve	78
<b>GAMMA™-WIRE CRETE</b> , Wire Concrete Placement Hose	79
<b>TEX-CRETE</b> , Textile Concrete Hose	80
<b>SIGMA-DUTY MAX™</b> , NBR Suction Hose	81

## SANITARY

<b>GROWLER™</b> , Brewery Hose	83
<b>BALTHAZAR™ PLUS</b> , Winery Hose	84
<b>DAIRY-KING™</b> , Milk Hose	85
<b>ELIXIR™</b> , Distillery Hose	86
<b>SIGMA-LT-BLUE™</b> , FDA PVC Low Temp Suction Hose	87
<b>SIGMA-FDW™</b> , FDA PVC Grounded Food-Grade Suction Hose	88
<b>SIGMA-FD™</b> , FDA PVC Food-Grade Suction Hose	89
<b>TEX-WASHDOWN</b> , 300PSI Washdown Hose	90
<b>TEX-SANITRANS</b> , FDA Sanitary Discharge Hose	91
<b>TEX-SANIVAC</b> , FDA Sanitary Vacuum Hose	92
<b>CORNUCOPIA™</b> , All-Purpose Sanitary Hose	93



# TABLE OF CONTENTS



<b>SIGMA-POLY MHH™</b> , Polyurethane Food-Grade Suction & Discharge Hose	94
<b>TEX-STEAM™ FDA</b> , Food Grade Steam Hose	95
<b>FDA-BULK</b> , Food Grade Dry Material Discharge Hose	96
<b>FDA-HEAT</b> , FDA Hot Air Blower Hose	97



## COUPLINGS

<b>TEX-QD</b> , Quick Disconnect Fittings	100
<b>TEX-QD-HD</b> , Quick Disconnect Fittings	101
<b>TEX-RHS</b> , Round Hole Strainers	102
<b>SIGMA-CLAMP™</b> , Double Bolt Spiral Clamp	103
<b>SIGMA-COIL™</b> , Banding Coil	104
<b>CAM &amp; GROOVE COUPLING LINE</b> , Type A Adapter	105
<b>CAM &amp; GROOVE COUPLING LINE</b> , Type B Coupler	106
<b>CAM &amp; GROOVE COUPLING LINE</b> , Type C Coupler	107
<b>CAM &amp; GROOVE COUPLING LINE</b> , Type D Coupler	108
<b>CAM &amp; GROOVE COUPLING LINE</b> , Type E Coupler	109
<b>CAM &amp; GROOVE COUPLING LINE</b> , Type F Adapter	110
<b>CAM &amp; GROOVE COUPLING LINE</b> , Type Dust Cap	111
<b>CAM &amp; GROOVE COUPLING LINE</b> , Type Dust Plug	112
<b>FERRULE</b>	113
<b>KC-NIP</b> , KC NIPPLE	114
<b>MALE PIPE</b> , MALE PIPE THREAD CRIMP	115
<b>SLEEVE</b>	116
<b>FLANGES</b>	117
<b>MALE ADAPTERS</b> , Spool Adapter (Male X Male)	118
<b>FEMALE ADAPTERS</b> , Double Female Adapter (Female X Female)	119
<b>REDUCING ADAPTERS</b> , Coupler X Adapter - Reducing (Female X Male)	120
<b>BLAST FITTING</b> , Sandblast Coupling	121
<b>UNIVERSAL</b> , Universal Crowfoot	122

## NOTES:





## GAMMA™ - 10K MUD & CEMENTING HOSE







10,000 PSI hose designed for cementing services

Heavy duty 10,000 PSI hose designed for cementing services.



### TECHNICAL DATA

Standard	To API Spec. 7K FSL 0 *
Tube	Black, NBR
Cover	Black, abrasion, ozone and hydrocarbon resistant synthetic rubber
Reinforcement	Multiple layers of spiraled high tensile steel wire
Maximum Length	200 ft.
Operating Temperature	-40 F to +250 F
Branding	GAMMA™ - 10K MUD & CEMENTING HOSE 2" (50.8 mm) 10,000 PSI (690 bar) W.P. / 15,000 PSI (1,035 bar) T.P. MEETS OR EXCEEDS API Spec. 7K FSL 0
Couplings:	Must contact TEXCEL

 I.D.	 Part Number	 O.D.	 Working Pressure (psi)	 Test Pressure (psi)	 Bend Radius	 Lbs./Ft.
2"	HS10K-32	2-47/64"	10,000	15,000	35"	4.25

\*Non-Monogrammed



## GAMMA™ - SLIM HOLE ROTARY HOSE

4,000 PSI hose designed for drilling applications



### TECHNICAL DATA

Tube	Black, NBR
Cover	Black, abrasion, ozone and hydrocarbon resistant synthetic rubber
Reinforcement	Multiple layers of spiraled high tensile steel wire
Maximum Length	100 ft.
Safety Factor	2.5:1
Operating Temperature	-40 F to +250 F
Branding (Dual Layline)	GAMMA™ - SLIM HOLE ROTARY HOSE 2 1/2" (63.5mm) 4,000 PSI (276 bar) W.P. / 10,000 PSI (690 bar) B.P. 2.5:1 S.F.  SHR/H-40 TERA-GLIDE 2 1/2" -40 DN65 2,500 PSI (170 BAR) W.P. / 10,000 PSI (690) B.P. 4:1 S.F./ MSHA IC-84/43
Couplings:	Use GMCO™ 9000 SERIES Couplings

I.D.	Part Number	O.D.	Working Pressure (psi)	Burst Pressure (psi)	Bend Radius	Lbs./Ft.
2-1/2"	SH-SPH-2.5	3-9/64"	4,000	10,000	26"	4.57
3"	SH-SPH-3.0	3-36/64"	4,000	10,000	27"	4.93

## SUPRA™ - HPOJ

High Pressure Oil & Jetting Hose



### TECHNICAL DATA

Tube	Black, NBR (50% Aromatics (ORS))
Cover	Black, CR, extremely high abrasion and weather resistant
Reinforcement	Multiple steel wire plies
Maximum Length	100 ft.
Operating Temperature	-20 F to +194 F, up to 212 F for oil use only
Branding	SUPRA™ - HIGH PRESSURE OIL & JETTING HOSE
Couplings	Use GMCO™ 9000 SERIES Couplings

I.D.	Part Number	O.D.	Working Pressure (psi)	Test Pressure (psi)	Safety Factor	Bend Radius	Lbs./Ft.
4"	HPOJ-4.0	5-5/64"	1,600	4,000	2.5:1	20"	6.6
6"	HPOJ-6.0	7-9/64"	1,600	4,000	2.5:1	29"	10.9





# TEX-FUEL

Fuel Transfer Hose

A multi-use hose for transporting leaded, unleaded, lead substitutes, low-pressure brake fluid or diesel. Used in farm and barrel pump applications, as well as construction and industrial service where UL approval is not required.



## TECHNICAL DATA

Tube	Black, NBR (ARPM Class A)
Cover	Black, SBR/Nitrile blend compounded for oil and ozone resistance
Reinforcement	Braided polyester cords
Safety Factor	3:1
Temperature	-40°F to +190°F
Non-Conductive	1,800 megaOhm @ 1,000 volts
Grounding	Embedded Copper Wire
Branding	TEXCEL® TEX-FUEL - FUEL TRANSFER HOSE - <ID>- 200PSI WP (white ink letters)

# TEX-F.O.D.

Fuel Oil Delivery Hose

Designed for the transfer and delivery of fuels, oils, kerosene, diesel and other petroleum-based products for home, commercial, marine and industrial service. Its braided synthetic reinforcement allows for extreme flexibility, reduced twisting and ease of handling, while maintaining kink resistance. Drivers will prefer this hose because of its static conductive tube, abrasion and oil resistance.



## TECHNICAL DATA

Tube	Black, NBR (ARPM Class A)
Cover	Red, NBR (ARPM Class A)
Reinforcement	2 braided polyester cords
Safety Factor	4:1
Temperature	-40°F to +180°F
Branding	TEXCEL F.O.D. Fuel Oil Delivery Hose - <ID> - 250PSI WP LOT (white ink letters)

I.D.	Part Number	O.D.	Std. Length	Working Pressure (psi)	Lbs./Coil
3/4"	FU-12-C200-200W-	1-1/4"	200'	200	77.00
1"	FU-16-C200-200W-	1-5/8"	200'	200	104.00

I.D.	Part Number*	O.D.	Std. Length	Working Pressure (psi)	Lbs./Ft.
1"	FOD-16-XXX	1-3/4"	100'/125'/150'/175'	250	0.65
1-1/4"	FOD-20-XXX	1-7/8"	100'/125'/150'/175'	250	0.87
1-3/8"	FOD-22-XXX	1-11/16"	100'/125'/150'/175'	250	0.91
1-1/2"	FOD-24-XXX	1-13/16"	100'/125'/150'/175'	250	1.12
2"	FOD-32-XXX	2-1/4"	75'/100'	200	1.38

\*Replace XXX in Part Number with standard length required





# HBR4

## Low Pressure Suction/Return Hose

Low pressure hydraulic return line or suction line for petroleum- and water-based hydraulic fluids.



### TECHNICAL DATA

Tube	Black, Oil, fuel and heat resistant, NBR (ARPM Class A)
Cover	Black, smooth with cloth impression, oil, abrasion, weather and ozone resistant
Reinforcement	High tensile tire cord plies with dual helix wires
Temperature	-40°F to +212°F (-40°C to +100°C)
Branding	TEXCEL® HBR4-12 <ID> MSHA MEETS OR EXCEEDS SAE 100R4
Specifications	Meets or Exceeds SAE 100R4

Dash	I.D.		# Part Number	O.D.		Working Pressure		Burst Pressure		Bend Radius		Weight	
	Inch	Dn		Inch	mm	psi	bar	psi	bar	inch	mm	lbs/ft	Kg/mt
12	3/4	12	HBR4-12	1-13/60	32	300	21	1,200	84	2.17	55	0.47	0.70
16	1	25	HBR4-16	1-1/2	38	245	17	980	68	2.95	75	0.60	0.90
20	1 1/4	31	HBR4-20	1-77/100	45	200	14	800	56	3.35	85	0.96	1.44
24	1 1/2	38	HBR4-24	2-1/20	52	150	10	600	42	3.74	95	1.13	1.70
32	2	51	HBR4-32	2-14/25	65	100	7	400	28	5.51	140	1.37	2.05

# TEX-OVAC

## Oilfield Suction Hose

Texcel's exclusive design for rugged oilfield service where full suction and working pressures are required.



### TECHNICAL DATA

Tube	Black, specially compounded elastomer low oil swell	
Cover	Black, SBR/Nitrile blend compounded for oil and ozone resistance (smooth)	
Reinforcement	High tensile tire cord plies; dual helix wire	
Safety Factor	4:1	
Temperature	-20°F to +180°F	
Branding	TEXCEL® TEX-OVAC - OILFIELD SUCTION HOSE NOT FOR REFINED FUELS 150 PSI W.P.	
Safety Note	Not recommended for refined petroleum products	

I.D.	# Part Number	O.D.	Std. Length	Working Pressure (psi)	Vacuum (in./HG)	Bend Radius	Lbs./Ft.
1-1/2"	OVAC-1.5	1-59/64"	100'	150	29	6"	0.67
2"	OVAC-2.0	2-28/64"	100'	150	29	7"	0.87
3"	OVAC-3.0	3-32/64"	100'	150	29	9"	1.52
4"	OVAC-4.0	4-36/64"	100'	150	29	14"	3.32







# GAMMA™-FLEX OVAC

Corrugated Oilfield Suction Hose

Texcel's exclusive design for rugged oilfield service where full suction and working pressures are required. Corrugated cover for improved flexibility.



## TECHNICAL DATA

Tube	Black, specially compounded elastomer; low oil swell	
Cover	Black, SBR/Nitrile blend compounded for oil and ozone resistance (corrugated)	
Reinforcement	High tensile tire cord plies; dual helix wire	
Safety Factor	4:1	
Temperature	-20°F to +180°F	
Branding	TEXCEL® GAMMA™-FLEX OVAC - FLEXIBLE OILFIELD SUCTION HOSE NOT FOR REFINED FUELS 150 PSI W.P.	
Safety Note	Not recommended for refined petroleum products	
Features	Exceptional flexibility	

# TEX-FRAC

Frac Tank Hose

A heavy-duty frac tank hose ideal for handling salt and fresh water, tank bottoms, crude oil, drilling muds and mild solutions of hydrochloric acids.



## TECHNICAL DATA

Tube	Black, specially compounded elastomer; low oil swell	
Cover	Black, SBR/Nitrile blend compounded for oil and ozone resistance (corrugated)	
Reinforcement	High tensile tire cord plies; single helix wire	
Safety Factor	4:1	
Temperature	-40°F to +190°F	
Branding	TEXCEL® TEX-FRAC - FRAC TANK HOSE NOT FOR REFINED FUELS 150 PSI W.P.	
Safety Note	Not recommended for refined petroleum products	

I.D.	Part Number	O.D.	Std. Length	Working Pressure (psi)	Vacuum (in./HG)	Bend Radius	Lbs./Ft.
2"	GOV15F1-2.0	2-39/64"	100'	150	29	2"	1.05
3"	GOV15F1-3.0	3-32/64"	100'	150	29	3"	1.64
4"	GOV15F1-4.0	4-36/64"	100'	150	29	4"	2.58
6"	GOV15F1-6.0	6-51/64"	100'	150	29	8"	4.75

I.D.	Part Number	O.D.	Std. Length	Working Pressure (psi)	Vacuum (in./HG)	Bend Radius	Lbs./Ft.
8"	FRAC-8.0-100	9"	100'	150	25	18"	8.17





# TEX-FRAC ASSEMBLY

## Frac Tank Hose Assembly

This hose assembly is ideal for handling salt and fresh water, tank bottoms, crude oil, drilling muds and mild solutions of hydrochloric acids. This heavy-duty frac tank hose is assembled with female frac subs and carbon steel sleeves. Its corrugated cover allows for maximum flexibility.



### TECHNICAL DATA

Tube	Black, specially compounded elastomer; low oil swell
Cover	Black, SBR/Nitrile blend compounded for oil and ozone resistance (corrugated)
Reinforcement	High tensile tire cord plies; helix wire
Safety Factor	4:1
Temperature	-40°F to +190°F
Branding	TEXCEL® TEX-FRAC - FRAC TANK HOSE NOT FOR REFINED FUELS 150 PSI W.P.
Safety Note	Not recommended for refined petroleum products .The 39" hose with fittings will have. OAL 43.5" +/- 1"

### FITTINGS TECHNICAL DATA

Threads	General purpose ACME threads
Surface Finish	Machined and oiled
Interior Finish	Black enamel
Size	8"
Weight	18.78 lbs. each
Requirements	Material conforms to DI 65-45-12 requirements
Crimp Sleeves	Carbon steel

FEMALE FRAC SUB ENDS AND CRIMP SLEEVES ALSO SOLD SEPARATELY

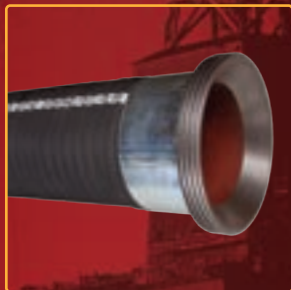

# TEX-OIL-D

## 200psi Oil Discharge Hose

Soft-wall discharge hose designed for use on trucks, docks and barges.



### TECHNICAL DATA

Tube	Black, Nitrile, 55% aromatics (ORS)
Cover	Black, Neoprene
Reinforcement	4 high tensile tire cord plies
Safety Factor	4:1
Temperature	-40°F to +200°F
Static Grounding	Braided copper wire runs length of hose
Branding	TEXCEL® TEX-OIL-D - PETROLEUM OIL TRANSFER / DISCHARGE HOSE 200 PSI W.P.
Safety Note	Not recommend for use on reels



I.D.	# Part Number	O.D.	Std. Length	Working Pressure (psi)	Lbs./Ft.
1-1/2"	OIL-D-1.5	2"	100'	200	0.96
2"	OIL-D-2.0	2-3/16"	100'	200	1.12
3"	OIL-D-3.0	3-3/16"	100'	200	1.89
4"	OIL-D-4.0	4-3/16"	100'	200	2.68
6"	OIL-D-6.0	6-5/16"	100'	200	5.89
8"	OIL-D-8.0	9-8/16"	100'	200	7.86



I.D.

Part Number

O.D.

OAL

Working Pressure (psi)

Vacuum (in./HG)

Assembled Weight (lbs.)

8"

AS-FRAC-8-43.5-FF

9"

43-1/2"

150

25

69



texcelindustrial.com

800.231.7116



texcelindustrial.com

800.231.7116





# GAMMA™-RED OIL

Oil Delivery Hose

Lightweight oil discharge hose for use in a variety of applications where an oil-resistant, soft-wall discharge hose is required.



## TECHNICAL DATA

Tube	Black, fuel and oil-resistant, NBR compound	
Cover	Red, oil, weather and abrasion-resistant EPDM/NR/SBR compound	
Reinforcement	High tensile tire cord plies and static wire	
Safety Factor	3:1	
Temperature	-30°F to +180°F	
Branding	TEXCEL® GAMMA™-RED OIL - OIL DELIVERY HOSE 150 PSI W.P.	
Safety Note	Not recommend for use on reels	

# GAMMA™-BLEND

400psi Blender/Fracturing Hose

A rugged hose designed for blender/fracturing operations in oilfield and gas exploration applications. The abrasion-resistant cover is constructed to withstand extended exposure to harsh, abrasive conditions typically seen in oilfield fracturing operations. Designed for the transfer of 98% water and sand mixtures, oil slurries and crude oil.



## TECHNICAL DATA

Tube	Black, fuel and oil-resistant, NBR compound	
Cover	Black, abrasion-resistant, SBR/Nitrile blend compound*	
Reinforcement	High tensile strength tire cord plies	
Safety Factor	4:1	
Temperature	-30°F to +180°F	
Branding	TEXCEL® GAMMA™-BLEND - BLENDER / FRACTURING DISCHARGE HOSE 400 PSI W.P.	

\*Additional UHMW heavy-duty cover application available for special order.

I.D.	Part Number	O.D.	Std. Length	Working Pressure (psi)	Lbs./Ft.
4"	GBF40S1-4.0	4-49/64"	100'/200'	400	3.02

I.D.	Part Number	O.D.	Std. Length	Working Pressure (psi)	Lbs./Ft.
2"	GRO15S1-2.0	2-32/64"	100'/200'	150	0.86
3"	GRO15S1-3.0	3-32/64"	100'/200'	150	1.24
4"	GRO15S1-4.0	4-34/64"	100'/200'	150	1.73





# GAMMA™-MULTI OIL

500psi Multi-Purpose Discharge Hose

This heavy-duty discharge hose can be used in a variety of applications in severe conditions such as oil waste, drilling muds, high pressure water or fracturing.



## TECHNICAL DATA

Tube	Black, fuel and oil-resistant, NBR compound	
Cover	Black, oil, weather and abrasion-resistant NR/SBR compound	
Reinforcement	High tensile tire cord plies; static wire	
Safety Factor	4:1	
Temperature	-30°F to +180°F	
Branding	TEXCEL® GAMMA™-MULTI OIL - MULTIPURPOSE DISCHARGE HOSE 500 PSI W.P.	

# GAMMA™-RED TANK

Red Tank Truck Hose

The industry standard for tank truck, in-plant and oilfield loading operations requiring a strong yet flexible hose. Red cover for easy identification.



## TECHNICAL DATA

Tube	Black, Nitrile, 55% aromatics (ORS)	
Cover	Red, Neoprene (smooth)	
Reinforcement	High tensile tire cord plies; dual helix wire	
Safety Factor	4:1	
Temperature	-40°F to +180°F	
Branding	TEXCEL® GAMMA™-RED TANK - RED TANK TRUCK HOSE 150 PSI W.P.	

I.D.	#	O.D.	Std. Length	Plies	Working Pressure (psi)	Lbs./Ft.
2"	GMO50S1-2.0	2- <sup>36</sup> / <sub>64</sub> "	100'/200'	4	500	1.22
3"	GMO50S1-3.0	3- <sup>43</sup> / <sub>64</sub> "	100'/200'	6	500	2.15
4"	GMO50S1-4.0	4- <sup>50</sup> / <sub>64</sub> "	100'/200'	8	500	3.31
5"	GMO50S1-5.0	5- <sup>52</sup> / <sub>64</sub> "	100'/200'	8	500	4.97

I.D.	#	O.D.	Std. Length	Working Pressure (psi)	Vacuum (in./HG)	Bend Radius	Lbs./Ft.
2"	RTA15S1-2.0	2- <sup>29</sup> / <sub>64</sub> "	100'/200'	150	29	8"	1.10
3"	RTA15S1-3.0	3- <sup>32</sup> / <sub>64</sub> "	100'/200'	150	29	13"	1.79
4"	RTA15S1-4.0	4- <sup>36</sup> / <sub>64</sub> "	100'/200'	150	29	19"	2.64





# GAMMA™-FLEX RED TANK

Red Corrugated Tank Truck Hose

A world-class hose for tank truck, in-plant and oilfield loading operations requiring a strong yet flexible hose. Red cover for easy identification. Exceptional flexibility (one-to-one ratio) for ease of handling.



## TECHNICAL DATA

Tube	Black, Nitrile, 55% aromatics (ORS)	
Cover	Red, Neoprene (corrugated)	
Reinforcement	High tensile tire cord plies; dual helix wire	
Safety Factor	4:1	
Temperature	-40°F to +180°F	
Branding	TEXCEL® GAMMA™-FLEX RED TANK - FLEXIBLE RED TANK TRUCK HOSE 150 PSI W.P.	
Features	Exceptional flexibility	

I.D.	#	O.D.	Std. Length	Working Pressure (psi)	Vacuum (in./HG)	Bend Radius	Lbs./Ft.
1-1/2"	RTA15F1-1.5	1-63/64"	100'/200'	150	29	1.5"	0.80
2"	RTA15F1-2.0	2-39/64"	100'/200'	150	29	2"	1.05
3"	RTA15F1-3.0	3-32/64"	100'/200'	150	29	3"	1.64
4"	RTA15F1-4.0	4-39/64"	100'/200'	150	29	4"	2.58

# GAMMA™-TANK

Tank Truck Hose

The industry standard for tank truck, in-plant and oilfield loading operations requiring a strong yet flexible hose.



## TECHNICAL DATA

Tube	Black, Nitrile, 55% aromatics (ORS), Minimum oil swell and low ECI value	
Cover	Black, Neoprene (smooth)	
Reinforcement	High tensile tire cord plies; dual helix wire	
Safety Factor	4:1	
Temperature	-40°F to +180°F	
Branding	TEXCEL® GAMMA™-TANK - TANK TRUCK HOSE 150 PSI W.P.	

I.D.	#	O.D.	Std. Length	Working Pressure (psi)	Vacuum (in./HG)	Bend Radius	Lbs./Ft.
1	GTA15S1-1.0	1-29/64"	100'	150	29	3"	0.43
1-1/4"	GTA15S1-1.25	1-43/64"	100'/200'	150	29	4"	0.70
1-1/2"	GTA15S1-1.5	1-59/64"	100'/200'	150	29	6"	0.84
2"	GTA15S1-2.0	2-29/64"	100'/200'	150	29	8"	1.10
2-1/2"	GTA15S1-2.5	2-61/64"	100'/200'	150	29	10"	1.48
3"	GTA15S1-3.0	3-32/64"	100'/200'	150	29	13"	1.79
4"	GTA15S1-4.0	4-36/64"	100'/200'	150	29	19"	2.64





# GAMMA™-FLEX TANK

Corrugated Tank Truck Hose

A world-class hose for tank truck, in-plant and oilfield loading operations requiring a strong yet flexible hose. Dramatic flexibility (one-to-one ratio, up to 4" inside diameter) for ease of handling.



## TECHNICAL DATA

Tube	Black, Nitrile, 55% aromatics (ORS)	
Cover	Black, Neoprene (corrugated)	
Reinforcement	High tensile tire cord plies; dual helix wire	
Safety Factor	4:1	
Temperature	-40°F to +180°F	
Branding	TEXCEL® GAMMA™-FLEX TANK - FLEXIBLE TANK TRUCK HOSE 150 PSI W.P.	
Features	Exceptional flexibility	



I.D.	# Part Number	O.D.	Std. Length	Working Pressure (psi)	Vacuum (in./HG)	Bend Radius	Lbs./Ft.
1-1/2"	GTA15F1-1.5	1-63/64"	100'/200'	150	29	1.5"	0.77
2"	GTA15F1-2.0	2-39/64"	100'/200'	150	29	2"	1.02
2-1/2"	GTA15F1-2.5	3"	100'/200'	150	29	2.5"	1.31
3"	GTA15F1-3.0	3-32/64"	100'/200'	150	29	3"	1.60
4"	GTA15F1-4.0	4-36/64"	100'/200'	150	29	4"	2.55
5"	GTA15F1-5.0	5-46/64"	100'	150	29	6"	3.86
6"	GTA15F1-6.0	6-48/64"	20'/100'	150	29	8"	4.17
8"	GTA15F1-8.0	8-52/64"	100'	150	29	10"	6.02

# GAMMA™-TANK 300

300psi Heavy-Duty Tank Truck Hose

Designed for offshore drilling and other demanding applications where a high working pressure is needed and longer lengths with fewer connections are desired.



## TECHNICAL DATA

Tube	Black, Nitrile, 55% aromatics (ORS)	
Cover	Black, Neoprene (smooth)	
Reinforcement	High tensile tire cord plies; dual helix wire	
Safety Factor	4:1	
Temperature	-40°F to +180°F	
Branding	TEXCEL® GAMMA™-TANK 300 - HEAVY-DUTY TANK TRUCK HOSE 300 PSI W.P.	



I.D.	# Part Number	O.D.	Std. Length	Working Pressure (psi)	Vacuum (in./HG)	Bend Radius	Lbs./Ft.
1-1/2"	GTA30S1-1.5	1-61/64"	100'/200'	300	29	5"	0.85
2"	GTA30S1-2.0	2-31/64"	100'/200'	300	29	7.5"	1.16
2-1/2"	GTA30S1-2.5	3"	100'/200'	300	29	12"	1.56
3"	GTA30S1-3.0	3-38/64"	100'/200'	300	29	16"	2.26
4"	GTA30S1-4.0	4-45/64"	100'/200'	300	29	20"	3.32





# GAMMA™-FLEX TANK 300

300psi Heavy-Duty Corrugated Tank Truck Hose

Designed for offshore drilling and other demanding applications where a high working pressure is needed and longer lengths with fewer connections are desired. Corrugated cover for greater flexibility.



## TECHNICAL DATA

Tube	Black, Nitrile, 55% aromatics (ORS)	
Cover	Black, Neoprene (corrugated)	
Reinforcement	High tensile tire cord plies; dual helix wire	
Safety Factor	4:1 *(2" - 6") 3:1 *(8")	
Temperature	-40°F to +180°F	
Branding	TEXCEL® GAMMA™-CORR TANK 300 - HEAVY DUTY CORRUGATED TANK TRUCK HOSE 300 PSI W.P.	
Features	Exceptional flexibility	

I.D.	#	O.D.	Std. Length	Working Pressure (psi)	Vacuum (in./HG)	Bend Radius	Lbs./Ft.
2"	GTA30C1-2.0	2- <sup>3</sup> / <sub>16</sub> "	100'/200'	300	29	4"	1.06
3"	GTA30C1-3.0	3- <sup>3</sup> / <sub>16</sub> "	100'/200'	300	29	7"	1.72
4"	GTA30C1-4.0	4- <sup>4</sup> / <sub>16</sub> "	100'/200'	300	29	10"	2.72
6"	GTA30C1-6.0	6- <sup>6</sup> / <sub>16</sub> "	100'	300	29	20"	5.41
8"	GTA30C1-8.0	9- <sup>1</sup> / <sub>16</sub> "	20'	300	29	30"	10.19



# GAMMA™-FLEX TANK 500

500psi Heavy-Duty Corrugated Tank Truck Hose

Heavy-duty and high pressure tank truck hose for the most demanding applications.



## TECHNICAL DATA

Tube	Black, Nitrile, 55% aromatics (ORS)	
Cover	Black, Neoprene (corrugated)	
Reinforcement	High tensile tire cord plies; dual helix wire	
Safety Factor	4:1	
Temperature	-40°F to +180°F	
Branding	TEXCEL® GAMMA™-CORR TANK 500 - HEAVY DUTY TANK TRUCK HOSE 500 PSI W.P.	

I.D.	#	O.D.	Std. Length	Working Pressure (psi)	Vacuum (in./HG)	Bend Radius	Lbs./Ft.
2"	GTA50C1-2.0	2- <sup>5</sup> / <sub>16</sub> "	100'/200'	500	29	6"	1.73
3"	GTA50C1-3.0	3- <sup>5</sup> / <sub>16</sub> "	100'/200'	500	29	9"	2.77
4"	GTA50C1-4.0	5- <sup>2</sup> / <sub>16</sub> "	100'/200'	500	29	13"	4.36



# TEX-OSD 250

250psi Oil Suction & Discharge Hose

Smooth bore dock hose with high strength construction and 250psi working pressure for the longest possible service life under severe conditions. Meets U.S.C.G. certification requirements when assembled per USCG 33CFR 154.500 specifications.



## TECHNICAL DATA

Tube	Black, Nitrile, 55% aromatics (ORS)
Cover	Black, Neoprene
Reinforcement	High tensile tire cord plies; dual helix on sizes 2"-4"; single helix wire on sizes 6"-12"
Safety Factor	4:1
Temperature	-40°F to +190°F
Branding	TEXCEL® TEX-OSD 250 - OIL SUCTION AND DISCHARGE HOSE 250 PSI W.P. MEETS USCG 33CFR 154.500
Specifications	Meets U.S.C.G. requirements



I.D.	# Part Number	O.D.	Std. Length	Working Pressure (psi)	Vacuum (in./HG)	Bend Radius	Lbs./Ft.
2"	OSD-2.0	2- <sup>60</sup> / <sub>64</sub> "	100'	250	29	8"	2.15
3"	OSD-3.0	4- <sup>16</sup> / <sub>64</sub> "	100'	250	29	11"	3.41
4"	OSD-4.0	5- <sup>20</sup> / <sub>64</sub> "	100'	250	29	15"	4.87
6"	OSD-6.0	7- <sup>24</sup> / <sub>64</sub> "	100'	250	29	25"	8.18
8"	OSD-8.0	9- <sup>48</sup> / <sub>64</sub> "	100'	250	29	31"	14.35
10"	OSD-10.0	12"	40'	250	29	36"	20.49
12"	OSD-12.0	14- <sup>8</sup> / <sub>64</sub> "	40'	250	29	40"	26.49

# GAMMA-OBL 250

Built-In Flanges Oil Suction & Discharge Assemblies

This smooth bore dock hose is manufactured with built-in carbon steel 150# ANSI flanges. Meets U.S.C.G. certification requirements per USCG 33CFR 154.500.

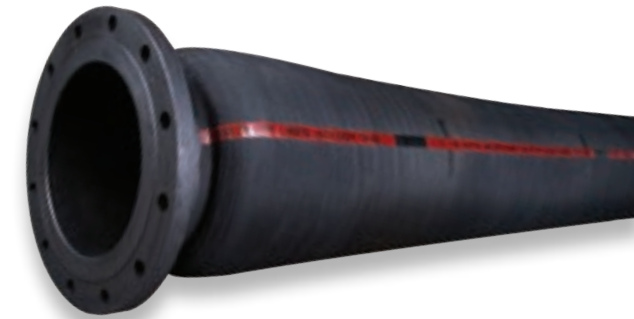

## TECHNICAL DATA

Tube	Black, Nitrile, 55% aromatics (ORS)
Cover	Black, Neoprene
Reinforcement	High tensile tire cord plies; helix wire
Safety Factor	4:1
Temperature	-40°F to +190°F
Ends	ANSI 150# carbon steel built-in fixed by floating flanges
Branding	TEXCEL® GAMMA-OBL 250 - OIL SERVICE SUCTION AND DISCHARGE HOSE 250 PSI W.P. MEETS USCG 33CFR 154.500
Specifications	Meets U.S.C.G. requirements

ANSI Flanges	Assembly Dimensions	# Part Number	O.D.	Working Pressure (psi)	Vacuum (in./HG)	Bend Radius	Lbs./Assembly
	4" x 10'	OBL-4-10-FL	4- <sup>53</sup> / <sub>64</sub> "	250	29	20"	94
	4" x 20'	OBL-4-20-FL	4- <sup>53</sup> / <sub>64</sub> "	250	29	20"	134
	6" x 10'	OBL-6-10-FL	7- <sup>1</sup> / <sub>64</sub> "	250	29	30"	167
	6" x 20'	OBL-6-20-FL	7- <sup>1</sup> / <sub>64</sub> "	250	29	30"	244
	6" x 25'	OBL-6-25-FL	7- <sup>1</sup> / <sub>64</sub> "	250	29	30"	286
	6" x 30'	OBL-6-30-FL	7- <sup>1</sup> / <sub>64</sub> "	250	29	30"	330
	6" x 40'	OBL-6-40-FL	7- <sup>1</sup> / <sub>64</sub> "	250	29	30"	396
	6" x 50'	OBL-6-50-FL**	7- <sup>1</sup> / <sub>64</sub> "	250	29	30"	474
	8" x 10'	OBL-8-10-FL	9- <sup>15</sup> / <sub>64</sub> "	250	29	48"	250
Built-In Fixed x Floating Flanged Assemblies	8" x 20'	OBL-8-20-FL	9- <sup>15</sup> / <sub>64</sub> "	250	29	48"	372
	8" x 25'	OBL-8-25-FL	9- <sup>15</sup> / <sub>64</sub> "	250	29	48"	432
	8" x 30'	OBL-8-30-FL	9- <sup>15</sup> / <sub>64</sub> "	250	29	48"	485
	8" x 35'	OBL-8-35-FL	9- <sup>15</sup> / <sub>64</sub> "	250	29	48"	564
	8" x 50'	OBL-8-50-FL**	9- <sup>15</sup> / <sub>64</sub> "	250	29	48"	754
	10" x 10'	OBL-10-10-FL	11- <sup>37</sup> / <sub>64</sub> "	250	29	60"	350
	10" x 20'	OBL-10-20-FL	11- <sup>37</sup> / <sub>64</sub> "	250	29	60"	520
	10" x 25'	OBL-10-25-FL	11- <sup>37</sup> / <sub>64</sub> "	250	29	60"	610
	12" x 10'	OBL-12-10-FL	13- <sup>45</sup> / <sub>64</sub> "	250	29	96"	510
	12" x 20'	OBL-12-20-FL	13- <sup>45</sup> / <sub>64</sub> "	250	29	96"	729
	12" x 25'	OBL-12-25-FL	13- <sup>45</sup> / <sub>64</sub> "	250	29	96"	850
	*14" x 10'	OBL-14-10-FL	15- <sup>46</sup> / <sub>64</sub> "	250	29	112"	575
	*14" x 20'	OBL-14-20-FL	15- <sup>46</sup> / <sub>64</sub> "	250	29	112"	848







# SIGMA-TDG™

## Tank Drop Hose

High quality tank drop hose designed with specially compounded, non-permeable polyurethane, designed to be compatible with gasoline, diesel and most biofuels, such as ethanol (up to E98) and biodiesel (B100 meeting ASTM D-6751). Extremely flexible, even in sub-zero temperatures.



### TECHNICAL DATA

Construction	Clear, specially compounded polyurethane with a rigid PVC right-handed helix (green) with spiraled synthetic yarn	
Safety Factor	4:1	
Temperature	-40°F to +150°F (service temperature depends on actual application)	
Grounding	Embedded tin coated copper wire	
Branding	TEXCEL® SIGMA™-TDG - TANK DROP HOSE - <ID>-LOT	
Compared To	TDH Tigerdrop Clear	
Sleeves	SIGMA-TDG™-Sleeves (flexible PVC banding sleeves) or SIGMA-COIL™ (banding coils) are recommended to accurately follow assembly procedures	
Features	Compatible with ethanol up to E98 & biodiesel up to B100	

I.D.	Part Number	O.D.	Std. Length	Working Pressure (psi)	Vacuum (in./HG)	Bend Radius	Lbs./Ft.
3"	SPVC-TDG-3.0	3.63"	20'/60'/100'	65	29	6"	1.21
4"	SPVC-TDG-4.0	4.73"	20'/60'/100'	65	29	8"	1.72

# SIGMA-TDHD™

## Heavy-Duty Tank Drop Hose

High quality gasoline tank drop hose that is lightweight and flexible with a high abrasion resistant helix for easy drag and handling. Flexible, even in sub-zero temperatures. It's suitable for the transfer of gasoline, ethanol blends (up to E15) and other petroleum products with an aromatic content of 40% or less.



### TECHNICAL DATA

Construction	Black, specially compounded NBR/PVC (Up to 40% Aromatics) – static dissipating with a Rigid, orange, right-handed PVC helix with spiraled synthetic yarn	
Safety Factor	4:1	
Temperature	-40°F to +150°F (service temperature depends on actual application)	
Grounding	Embedded tin coated copper wire	
Branding	TEXCEL® SIGMA™-TDHD - HEAVY DUTY TANK DROP HOSE - <ID>-LOT	
Compared To	120LT	
Sleeves	SIGMA-TDHD™-Sleeves (flexible PVC banding sleeves) or SIGMA-COIL™ (banding coils) are recommended to accurately follow assembly procedures	
Features	Compatible with gasoline and ethanol blends up to E15	

I.D.	Part Number	O.D.	Std. Length	Working Pressure (psi)	Vacuum (in./HG)	Bend Radius	Lbs./Ft.
2"	SPVC-TDHD-2.0	2.63"	20'/60'/100'	65	29	5"	1.12
3"	SPVC-TDHD-3.0	3.81"	20'/60'/100'	65	29	6"	1.38
4"	SPVC-TDHD-4.0	4.72"	20'/60'/100'	65	29	8"	2.19





# SIGMA-TD 150™

150psi Heavy-Duty Tank Drop Hose

This lightweight drop hose is designed for higher working pressure applications where 150psi is desired. It's suitable for the transfer of gasoline, ethanol blends (up to E15), and other petroleum products with an aromatic content of 40% or less in both drop and pump off service applications. Its rugged and abrasion-resistant construction allows for a low coefficient of friction for ease and maneuverability.



## TECHNICAL DATA

Construction	Black, specially compounded NBR/PVC (up to 60% aromatics) – static-dissipating with a rigid PVC right-handed helix (red) and spiraled synthetic yarn	
Safety Factor	4:1	
Temperature	-40°F to +150°F (service temperature depends on actual application)	
Grounding	Embedded tin coated copper wire	
Branding	TEXCEL® SIGMA-TD150™ - HEAVY DUTY TANK DROP HOSE 150 PSI W.P. -<ID>-LOT	
Compared To	SP353	
Sleeves	SIGMA-TD150™ Sleeves (flexible PVC banding sleeves) or SIGMA-COIL™ (banding coils) are recommended to accurately follow assembly procedures	
Features	Designed for use at a higher 150psi working pressure	

## CAUTION

Hose fabrications should be performed only by experienced personnel. Static wire must be properly embedded, grounded and tested prior to use to assure grounding of hose and hose assembly.

# SIGMA-VRM™

Medium-Duty Yellow Vapor Recovery Hose

High quality vapor recovery hose for medium-duty applications. Specially compounded, non-permeable polyurethane designed to be compatible with gasoline, diesel and most biofuels, such as ethanol (up to E98) and biodiesel vapors (B100 meeting ASTM D 6751). Extremely flexible, even in sub-zero temperatures.



## TECHNICAL DATA

Construction	Clear, specially compounded polyurethane with a yellow, rigid PVC, right-handed helix	
Temperature	-40°F to +150°F (service temperature depends on actual application)	
Grounding	Embedded tin coated copper wire	
Branding	TEXCEL® SIGMA-VRM™ - MEDIUM DUTY VAPOR RECOVERY HOSE -<ID>-LOT	
Compared To	Tigervapor/ST-120-VP	
Sleeves	SIGMA-VR™-Sleeves (flexible PVC banding sleeves) or SIGMA-COIL™ (banding coils) are recommended to accurately follow assembly procedures	

I.D.	Part Number	O.D.	Std. Length	Working Pressure (psi)	Vacuum (in./HG)	Bend Radius	Lbs./Ft.
2"	SPVC-TD150-2.0	2.73"	20'/60'/100'	150	29	6"	1.26
3"	SPVC-TD150-3.0	3.75"	20'/60'/100'	150	29	7"	1.55
4"	SPVC-TD150-4.0	4.88"	20'/60'/100'	150	29	9"	2.49

I.D.	Part Number	O.D.	Std. Length	Working Pressure (psi)	Vacuum (in./HG)	Bend Radius	Lbs./Ft.
2"	SPVC-VRM-2.0	3"	20'/60'/100'	17	29	3"	0.52
3"	SPVC-VRM-3.0	3-½"	20'/60'/100'	11	29	3.5"	0.77
4"	SPVC-VRM-4.0	4-½"	20'/60'/100'	9	29	4.5"	1.11





# SIGMA-VRH™

Heavy-Duty Red Vapor Recovery Hose

High quality vapor recovery hose for heavy-duty applications. Specially compounded, non-permeable polyurethane designed to be compatible with gasoline, diesel and most biofuels, such as ethanol (up to E98) and biodiesel vapors (B100 meeting ASTM D-6751). Extremely flexible, even in sub-zero temperatures.



## TECHNICAL DATA

Construction	Clear, specially compounded polyurethane with a bright red, rigid PVC, right-handed helix
Temperature	-40°F to +150°F (service temperature depends on actual application)
Grounding	Embedded tin coated copper wire
Branding	TEXCEL® SIGMA™-VRH - HEAVY DUTY VAPOR RECOVERY HOSE -<ID>-LOT
Compared To	Tigervapor HD
Sleeves	SIGMA-VR™-Sleeves (flexible PVC banding sleeves) or SIGMA-Coil™ (banding coils) are recommended to accurately follow assembly procedures



I.D.	Part Number	O.D.	Std. Length	Working Pressure (psi)	Vacuum (in./HG)	Bend Radius	Lbs./Ft.
3"	SPVC-VRH-3.0	3-37/64"	20'/60'/100'	13	29	4.5"	0.96
4"	SPVC-VRH-4.0	4-38/64"	20'/60'/100'	11	29	5.5"	1.28

# SIGMA-BANDING SLEEVES™

Plastic banding sleeves for use with SIGMA™ SERIES Tank Drop hose products. The suggested usage is in 12" sections per hose end to prevent band clamps from slipping, cutting into the exterior helix and improves fitting retention.

## TECHNICAL DATA

Material	Non-food grade, flexible PVC
Temperature	-40°F to +150°F (service temperature depends on actual application)
Features	Designed for right-handed spiral hose

## GREEN BANDING SLEEVE FOR: SIGMA-TDG

I.D.	Part Number	Std. Length	Lbs./Ft.
3"	3.0-SLEEVE-TDG	3'	3.20
4"	4.0-SLEEVE-TDG	3'	3.75



## ORANGE BANDING SLEEVE FOR: SIGMA-TDHD

I.D.	Part Number	Std. Length	Lbs./Ft.
2"	2.0-SLEEVE-TDHD	3'	1.10
3"	3.0-SLEEVE-TDHD	3'	3.20
4"	4.0-SLEEVE-TDHD	3'	3.75



## RED BANDING SLEEVE FOR: SIGMA-TD 150

I.D.	Part Number	Std. Length	Lbs./Ft.
2"	2.0-SLEEVE-TD150	3'	1.10
3"	3.0-SLEEVE-TD150	3'	3.20
4"	4.0-SLEEVE-TD150	3'	3.75



## YELLOW BANDING SLEEVE FOR: SIGMA-VRM AND VRH

I.D.	Part Number	Std. Length	Lbs./Ft.
2"	2.0-SLEEVE-VAPOR	3'	1.10
3"	3.0-SLEEVE-VAPOR	3'	3.20
4"	4.0-SLEEVE-VAPOR	3'	3.75





# GAMMA™ JETT







Water Jetting Hose

High pressure water jetting hose.



## TECHNICAL DATA

Tube	Black, NR/SBR smooth and abrasion resistant
Cover	Black, NR/SBR, high abrasion and weather resistant
Reinforcement	High tensile tire cord plies
Maximum Length	100 ft.
Temperature	-40 F to +185F
Branding	GAMMA™ JETT – WATER JETTING HOSE

					Safety	
I.D.	Part Number	O.D.	Working Pressure psi/bar	Burst Pressure psi/bar	Factor	Lbs./Ft.
2.5"	WJETT-2.5	3-5/64"	500	2,000	4:1	1.26
4"	WJETT-4.0	4-49/64"	500	2,000	4:1	2.44



# SIGMA-HD GREEN PVC™

Heavy-Duty Green PVC Water Suction Hose

Premium, heavy-duty yet economical construction for great durability. Smooth bore allows full production flow.



## TECHNICAL DATA

Construction	Olive green PVC with a green, tough vinyl helix
Safety Factor	3:1
Temperature	-4°F to +150°F
Compared To	110GR/Series J
Branding	TEXCEL® SIGMA-HD GREEN PVC™ - HEAVY DUTY WATER SUCTION HOSE -<ID>-LOT
Safety Note	Service temperature depends on actual application

I.D.	# Part Number	O.D.	Std. Length	Working Pressure (psi)	Vacuum (in./HG)	Bend Radius	Lbs./Ft.
1-1/2"	SPVC-GR-1.5	1.77"	100'	85	29	4"	0.39
2"	SPVC-GR-2.0	2.24"	100'	70	29	5"	0.57
2-1/2"	SPVC-GR-2.5	2.80"	100'	70	29	6.5"	0.74
3"	SPVC-GR-3.0	3.27"	100'	65	29	8.5"	0.94
4"	SPVC-GR-4.0	4.67"	100'	65	29	12"	1.48
5"	SPVC-GR-5.0	5.51"	100'	50	29	14"	2.15
6"	SPVC-GR-6.0	6.93"	20'/100'	50	29	15"	2.89
8"	SPVC-GR-8.0	8.66"	20'	45	29	20"	4.37
10"	POLY-G-10.0	11.34"	20'/25'	30	29	35"	7.45
12"	POLY-G-12.0	13.39"	20'/25'	30	29	40"	8.87

# SIGMA-HD CLEAR PVC™

Heavy-Duty Clear PVC Water Suction Hose

Premium, heavy-duty yet economical construction for great durability. Clear PVC allows visual confirmation of product flow.



## TECHNICAL DATA

Construction	Clear PVC (smooth bore) with a white, tough vinyl helix
Safety Factor	3:1
Temperature	-4°F to +150°F
Branding	TEXCEL® SIGMA-HD CLEAR PVC™ - HEAVY DUTY WATER SUCTION HOSE -<ID>-LOT
Compared To	110CL/Series H
Safety Note	Service temperature depends on actual application

I.D.	# Part Number	O.D.	Std. Length	Working Pressure (psi)	Vacuum (in./HG)	Bend Radius	Lbs./Ft.
3/4"	SPVC-CL-75	0.95"	100'	100	29	2"	0.20
1"	SPVC-CL-1.0	1.26"	100'	100	29	2.5"	0.27
1-1/2"	SPVC-CL-1.5	1.82"	100'	85	29	4"	0.39
2"	SPVC-CL-2.0	2.39"	100'	70	29	5"	0.57
2-1/2"	SPVC-CL-2.5	2.93"	100'	70	29	6.5"	0.74
3"	SPVC-CL-3.0	3.43"	100'	65	29	8.5"	0.94
*4"	SPVC-CL-4.0	4.53"	100'	65	29	12"	1.48
*5"	SPVC-CL-5.0	5.55"	100'	50	29	14"	2.15
*6"	SPVC-CL-6.0	6.67"	20'/100'	50	29	15"	2.89
*8"	SPVC-CL-8.0	8.83"	20'	45	29	20"	4.37





# SIGMA-PB DISCHARGE™

Blue PVC Lay-Flat Discharge Hose

Premium-quality, lightweight, lay-flat PVC hose that is economical and easy to handle. Excellent for pump discharge applications.



## TECHNICAL DATA

Construction	Blue, homogeneous virgin PVC with high tensile polyester yarn
Safety Factor	3:1
Temperature	-10°F to +120°F
Branding	TEXCEL® SIGMA-PB DISCHARGE™ - WATER DISCHARGE HOSE -<ID>-LOT
Safety Note	Service temperature depends on actual application

I.D.	Part Number	Std. Length	Working Pressure (psi)	Lbs./Ft.
1"	SPVC-PB-1.0-300	300'	90	0.10
1-¼"	SPVC-PB-1.25-300	300'	85	0.12
1-½"	SPVC-PB-1.5-300	300'	70	0.14
2"	SPVC-PB-2.0-300	300'	65	0.18
2-½"	SPVC-PB-2.5-300	300'	60	0.26
3"	SPVC-PB-3.0-300	300'	55	0.31
4"	SPVC-PB-4.0-300	300'	55	0.36
5"	SPVC-PB-5.0-300	300'	45	0.64
6"	SPVC-PB-6.0-300	300'	45	0.73
8"	SPVC-PB-8.0-300	300'	45	1.21
10"	SPVC-PB-10.0-100	100'	35	1.81
12"	SPVC-PB-12.0-100	100'	30	1.95

# SIGMA-PB DISCHARGE™

Blue PVC Lay-Flat Discharge Hose Coupled

Coupled Premium-quality, lightweight, lay-flat PVC hose that is economical and easy to handle. Excellent for pump discharge applications. Coupled with aluminum camlocks or pinlugs.



## TECHNICAL DATA

Construction	Blue, homogeneous virgin PVC with high tensile polyester yarn coupled with aluminum camlocks or pinlugs
Safety Factor	3:1
Temperature	-10°F to +120°F
Branding	TEXCEL® SIGMA-PB DISCHARGE™ - WATER DISCHARGE HOSE -<ID>-LOT
Safety Note	Service temperature depends on actual application

I.D.	Part Number	Std. Length	Working Pressure (psi)	Lbs./Ft.
1-½"	SPVC-PB-1.5-50-CXE	50'	70	8.38
1-½"	SPVC-PB-1.5-50-LUG	50'	70	8.38
2"	SPVC-PB-2.0-50-CXE	50'	65	9.22
2"	SPVC-PB-2.0-50-LUG	50'	65	9.22
3"	SPVC-PB-3.0-50-CXE	50'	55	14.62
3"	SPVC-PB-3.0-50-LUG	50'	55	14.62
4"	SPVC-PB-4.0-50-CXE	50'	55	22.66
4"	SPVC-PB-4.0-50-LUG	50"	55	22.66
5"	SPVC-PB-5.0-50-CXE	50'	45	32.46
6"	SPVC-PB-6.0-50-CXE	50'	45	39.46
6"	SPVC-PB-6.0-50-LUG	50'	45	39.46



# SIGMA-RH DISCHARGE™

Heavy-Duty Red PVC Lay-Flat Discharge Hose

A heavy-duty PVC lay-flat hose designed for higher pressure applications. The exclusive “through the weave” process ensures the highest quality and durability. An ideal hose for pump discharge, tank cleaning, dewatering, irrigation and wash down applications.

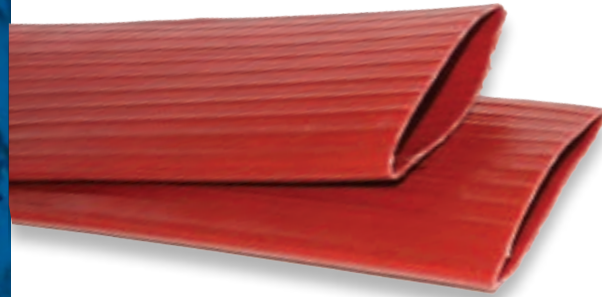

## TECHNICAL DATA

Tube and Cover	Red, homogeneous virgin PVC
Reinforcement	High tensile polyester yarn
Safety Factor	3:1
Temperature	-10°F to +120°F
Branding	TEXCEL® SIGMA-RH DISCHARGE™ - HEAVY DUTY WATER DISCHARGE HOSE -<ID>-LOT
Safety Note	Service temperature depends on actual application

I.D.	Part Number	Std. Length	Working Pressure (psi)	Lbs./Ft.
1-1/2"	SPVC-RH-1.5-300	300'	150	0.20
2"	SPVC-RH-2.0-300	300'	150	0.28
3"	SPVC-RH-3.0-300	300'	150	0.57
4"	SPVC-RH-4.0-300	300'	130	0.67
6"	SPVC-RH-6.0-300	300'	120	1.34
8"	SPVC-RH-8.0-300	300'	90	1.88

# SIGMA-RH DISCHARGE™

Heavy-Duty Red PVC Lay-Flat Discharge Hose Coupled

Coupled heavy-duty PVC lay-flat hose designed for higher pressure applications. The exclusive “through the weave” process ensures the highest quality and durability. An ideal hose for pump discharge, tank cleaning, dewatering, irrigation and wash down applications. Coupled with aluminum camlocks or pinlugs.



## TECHNICAL DATA

Tube and Cover	Red, homogeneous virgin PVC, coupled with aluminum camlocks or pinlugs
Reinforcement	High tensile polyester yarn
Safety Factor	3:1
Temperature	-10°F to +120°F
Branding	TEXCEL® SIGMA-RH DISCHARGE™ - HEAVY DUTY WATER DISCHARGE HOSE -<ID>-LOT
Safety Note	Service temperature depends on actual application

I.D.	Part Number	Std. Length	Working Pressure (psi)	Lbs./Ft.
1-1/2"	SPVC-RH-1.5-50-CXE	50'	150	10.75
1-1/2"	SPVC-RH-1.5-50-LUG	50'	150	10.75
2"	SPVC-RH-2.0-50-CXE	50'	150	15.25
2"	SPVC-RH-2.0-50-LUG	50'	150	15.25
3"	SPVC-RH-3.0-50-CXE	50'	150	30.25
3"	SPVC-RH-3.0-50-LUG	50'	150	30.25
4"	SPVC-RH-4.0-50-CXE	50'	130	36.60
4"	SPVC-RH-4.0-50-LUG	50'	130	36.60
6"	SPVC-RH-6.0-50-CXE	50'	90	72.20
6"	SPVC-RH-6.0-50-LUG	50'	90	72.20



# TEX-MILL

Mill Discharge Hose (Single Jacket)

Lightweight general purpose hose designed for open-ended discharge applications. 300psi acceptance test/150psi working pressure.



## TECHNICAL DATA

Tube	Synthetic rubber EPDM
Reinforcement	White, 100% polyester jacket
Temperature	-58°F to +176°F
Branding	TEXCEL® TEX-MILL - DISCHARGE HOSE -<ID>- 150 PSI SERVICE PRESSURE!
Packaging	Boxed
Safety Note	Not recommended for use as a fire hose

# SIGMA-PVC AQUA™

PVC Water Suction Hose

Heavy-duty suction and discharge hose for use in a variety of industries, such as rental pumping equipment and applications where the hose needs to slide easily, or visual confirmation of material flow is necessary.



## TECHNICAL DATA

Construction	Clear, flexible PVC with synthetic yarn and an orange, rigid PVC, right-handed helix	
Safety Factor	3:1	
Temperature	-4°F to +150°F	
Branding	TEXCEL® SIGMA-PVC AQUA™ - WATER SUCTION HOSE -<ID>- XXXPSI WP-LOT	
Compared To	SR/WST	
Safety Note	Service temperature depends on actual application	

I.D.	# Part Number	Bowl Size	Working Pressure (psi)	Std. Length	Lbs./Ft.
1-1/2"	MILL-1.5	1-3/4"	150	100'	0.20
2"	MILL-2.0	2-3/16"	150	100'	0.27
2-1/2"	MILL-2.5	2-13/16"	150	100'	0.38
3"	MILL-3.0	Use Camlocks	150	50'	0.46
4"	MILL-4.0	Use Camlocks	150	50'	0.65

I.D.	# Part Number	O.D.	Std. Length	Working Pressure (psi)	Vacuum (in./HG)	Bend Radius	Lbs./Ft.
1-1/2"	SPVC-AQUA-1.5	2.03"	100'	100	28	3"	0.47
2"	SPVC-AQUA-2.0	2.62"	100'	100	28	4"	0.71
3"	SPVC-AQUA-3.0	3.71"	100'	100	28	6"	1.14
4"	SPVC-AQUA-4.0	4.80"	100'	75	28	7"	1.75
5"	SPVC-AQUA-5.0	6.05"	100'	70	28	9"	3.00
6"	SPVC-AQUA-6.0	7.17"	20'/60'/100'	70	28	10"	3.90
8"	SPVC-AQUA-8.0	9.33"	15'/20'/25'/50'	70	28	16"	5.56
10"	SPVC-AQUA-10.0	10.86"	20'/25'	40	28	25"	8.68
12"	SPVC-AQUA-12.0	13.8"	20'	28	25	45"	10.30







# SIGMA-CLAMP™

Double Bolt Spiral Clamp

Double bolt spiral clamps are recommended for use with Texcel's SIGMA-Series PVC hoses with convoluted cover.



	 Hose Diameter	# Part Number	 Lbs./Each
Right Hand	1-1/2"	1.5-SP-CLAMP	0.29
	2"	2.0-SP-CLAMP	0.34
	2-1/2"	2.5-SP-CLAMP	0.63
	3"	3.0-SP-CLAMP	0.72
	4"	4.0-SP-CLAMP	1.21
	5"	5.0-SP-CLAMP	1.41
	6"	6.0-SP-CLAMP	2.29
	8"	8.0-SP-CLAMP	2.97
Left Hand	1-1/2"	1.5-SP-CLAMP-LH	0.29
	2"	2.0-SP-CLAMP-LH	0.34
	3"	3.0-SP-CLAMP-LH	0.72
	4"	4.0-SP-CLAMP-LH	1.21
	5"	5.0-SP-CLAMP-LH	1.41
	6"	6.0-SP-CLAMP-LH	2.29
	8"	8.0-SP-CLAMP-LH	2.97

# TEX-AQUA HD

Heavy-Duty Water Suction & Discharge Hose







Constructed with the highest quality compounds to provide maximum flexibility, long life and lighter weight for easy handling.









## TECHNICAL DATA

Tube	Black, SBR/EPDM blend	
Cover	Black, SBR/EPDM blend	
Reinforcement	High tensile tire cord plies; helix wire	
Safety Factor	3:1	
Temperature	-40°F to +180°F	
Ends	Soft cuffs available on 6" and 8" sizes only	
Branding	TEXCEL® TEX-AQUA HD - HEAVY DUTY WATER SUCTION & DISCHARGE HOSE XXX PSI W.P.	
Note	6" and 8" available in a smooth or corrugated cover For extra flexibility use 5"-12" corrugated	

## SMOOTH COVER

 I.D.	# Part Number	 O.D.	 Std. Length	 Working Pressure (psi)	 Vacuum (in./HG)	 Bend Radius	 Lbs./Ft.
1"	AQUA-HD-1.0	1-19/64"	100'	150	29	4"	0.50
1-1/4"	AQUA-HD-1.25	1-40/64"	100'	150	29	5"	0.62
1-1/2"	AQUA-HD-1.5	1-56/64"	100'	150	29	7"	0.85
2"	AQUA-HD-2.0	2-28/64"	100'/200'	150	29	10"	1.06
2-1/2"	AQUA-HD-2.5	2-56/64"	100'	150	29	11"	1.31
3"	AQUA-HD-3.0	3-29/64"	100'/200'	150	29	12"	1.73
4"	AQUA-HD-4.0	4-32/64"	100'/200'	150	29	14"	2.55
6"	AQUA-HD-S-6.0	6-40/64"	20'/100'	150	25	19"	5.90
8"	AQUA-HD-S-8.0	8-40/64"	20'/100'	150	25	20"	7.90

## CORRUGATED COVER

 I.D.	# Part Number	 O.D.	 Std. Length	 Working Pressure (psi)	 Vacuum (in./HG)	 Bend Radius	 Lbs./Ft.
5"	AQUA-HD-5.0	5-41/64"	100'	150	25	14"	4.50
6"	AQUA-HD-6.0	6-44/64"	20'/100'	150	25	15"	5.50
8"	AQUA-HD-8.0	8-48/64"	20'/100'	150	25	16"	7.50
10"	AQUA-HD-10.0	10-48/64"	20'/25'	50	20	18"	10.00
12"	AQUA-HD-12.0	12-56/64"	20'/25'	50	20	20"	12.00



# TEX-FLO 2MD

Medium-Duty 2-Ply Water Discharge Hose

Soft-wall design gives similar performance to a lay-flat hose, but with increased abrasion resistance and tensile strength.



## TECHNICAL DATA

Tube	Black, SBR/EPDM blend	
Cover	Black, SBR/EPDM blend	
Reinforcement	High tensile tire cord plies	
Safety Factor	3:1	
Temperature	-40°F to +180°F	
Branding	TEXCEL® TEX-FLO 2MD - WATER DISCHARGE HOSE 2PLY XXX PSI WP	

I.D.	Part Number	O.D.	Std. Length	Fabric Plies	Working Pressure (psi)	Lbs./Ft.
1-1/2"	FLO-2MD-1.5	1-52/64"	100'	2	150	0.41
2"	FLO-2MD-2.0	2-20/64"	100'	2	150	0.52
2-1/2"	FLO-2MD-2.5	2-52/64"	100'	2	150	0.65
3"	FLO-2MD-3.0	3-20/64"	100'	2	150	0.77
4"	FLO-2MD-4.0	4-20/64"	100'	2	150	1.06
6"	FLO-2MD-6.0	6-22/64"	100'	2	100	1.88
8"	FLO-2MD-8.0	8-23/64"	100'	2	100	2.61
10"	FLO-2MD-10.0	10-27/64"	100'	2	80	3.47

# TEX-FLO 4HD

Heavy-Duty 4-Ply Water Discharge Hose

Soft-wall design gives similar performance to a lay-flat hose, but with increased abrasion resistance and tensile strength. FLO-HD is made of a premium-quality SBR/EPDM blend for maximum weather resistance and life in abusive service.



## TECHNICAL DATA

Tube	Black, SBR/EPDM blend	
Cover	Black, SBR/EPDM blend	
Reinforcement	High tensile tire cord plies	
Safety Factor	3:1	
Temperature	-40°F to +180°F	
Branding	TEXCEL® TEX-FLO 4HD - HEAVY DUTY WATER DISCHARGE HOSE 4PLY XXXPSI WP	

I.D.	Part Number	O.D.	Std. Length	Fabric Plies	Working Pressure (psi)	Lbs./Ft.
1-1/2"	FLO-4HD-1.5	1-58/64"	100'	4	250	0.56
2"	FLO-4HD-2.0	2-26/64"	100'	4	250	0.73
2-1/2"	FLO-4HD-2.5	2-58/64"	100'	4	250	0.88
3"	FLO-4HD-3.0	3-26/64"	100'	4	250	1.04
4"	FLO-4HD-4.0	4-27/64"	100'	4	200	1.41
4-1/2"	FLO-4HD-4.5	4-59/64"	100'	4	200	1.58
5"	FLO-4HD-5.0	5-28/64"	100'	4	200	1.89
6"	FLO-4HD-6.0	6-29/64"	100'	4	200	2.48
8"	FLO-4HD-8.0	8-30/64"	100'	4	200	3.39
10"	FLO-4HD-10.0	10-34/64"	100'	4	150	4.44
12"	FLO-4HD-12.0	12-34/64"	50'	4	150	5.30



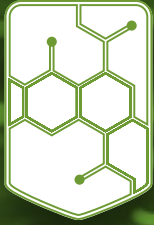

# WORKING PRESSURE RECOMMENDATIONS

Working pressures are in accordance with ARPM design safety factors at ambient temperatures (approximately 70°F). Texcel cautions against using a hose outside the stated temperature limits. Even within these limits, coupling type and hose size can negatively impact performance at higher temperatures. For optimum performance and safety, we recommend reducing the maximum working pressure as indicated below:

**80° to 150°F** – Reduce working pressure by 15%

**150° to 225°F** – Reduce working pressure by 30%

**Over 225°F** – Reduce working pressure by 50%

## CAUTION

Consult the Chemical Resistance Chart and the Safety Warning for each application. It is advisable to test the tube material under actual service conditions prior to initial use.



# GAMMA™-FLEX XLPE

Cross-Linked Polyethylene Chemical Hose

Designed to handle a wide range of chemicals, solvents and corrosive liquids in both pressure and suction service.



## TECHNICAL DATA

Tube	Clear, cross-linked polyethylene	
Cover	Green, EPDM (corrugated)	
Reinforcement	High tensile tire cord plies; dual helix wire	
Safety Factor	4:1	
Temperature	-40°F to +212°F	
Branding	TEXCEL® GAMMA™-FLEX XLPE - CHEMICAL SUCTION AND DISCHARGE HOSE 200 PSI W.P. XLPE TUBE	
Safety Note	Temperature rating depends on specific chemical conveyed and concentration	
Features	Exceptional flexibility	

I.D.	Part Number	O.D.	Std. Length	Working Pressure (psi)	Vacuum (in./HG)	Bend Radius	Lbs./Ft.
1"	GXL20F1-1.0	1- <sup>30</sup> / <sub>64</sub> "	100'/200'	200	29	2.5"	0.56
1-1/2"	GXL20F1-1.5	1- <sup>62</sup> / <sub>64</sub> "	100'/200'	200	29	3"	0.80
2"	GXL20F1-2.0	2- <sup>32</sup> / <sub>64</sub> "	100'/200'	200	29	4"	1.15
2-1/2"	GXL20F1-2.5	3"	100'/200'	200	29	5"	1.41
3"	GXL20F1-3.0	3- <sup>35</sup> / <sub>64</sub> "	100'/200'	200	29	6"	1.89
4"	GXL20F1-4.0	4- <sup>39</sup> / <sub>64</sub> "	100'/200'	200	29	8"	2.69

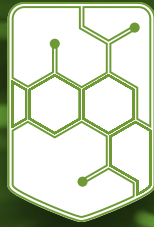

# GAMMA™-FLEX UHMW

Ultra-High Molecular Weight Polyethylene Chemical Hose

A more flexible chemical hose designed to handle 98% of all chemicals, solvents and corrosive liquids in both pressure and suction service.



## TECHNICAL DATA

Tube	Clear, ultra-high molecular weight polyethylene
Cover	Blue or green*, EPDM (corrugated)
Reinforcement	High tensile tire cord plies; dual helix wire
Safety Factor	4:1
Temperature	-40°F to +250°F (intermittent)
Branding	TEXCEL® GAMMA™-FLEX UHMW - CHEMICAL SUCTION AND DISCHARGE HOSE 200 PSI W.P. UHMW TUBE
Safety Note	Temperature rating depends on specific chemical conveyed and concentration
Features	Exceptional flexibility



\*The material code defaults to a Blue cover. To order Green cover insert the letter G before hyphen in part number.

\*\*Only Available in Blue.

I.D.	Part Number	O.D.	Std. Length	Working Pressure (psi)	Vacuum (in./HG)	Bend Radius	Lbs./Ft.
1"	GUH20C1-1.0	1-29/64"	100'/200'	200	29	2.5"	0.57
1-1/4"***	GUH20C1-1.25	1-45/64"	100'/200'	200	29	2.75"	0.62
1-1/2"	GUH20C1-1.5	1-61/64"	100'/200'	200	29	3"	0.81
2"	GUH20C1-2.0	2-31/64"	100'/200'	200	29	4"	1.11
2-1/2"	GUH20C1-2.5	2-63/64"	100'/200'	200	29	5"	1.40
3"	GUH20C1-3.0	3-35/64"	100'/200'	200	29	6"	1.77
4"	GUH20C1-4.0	4-36/64"	100'/200'	200	29	8"	2.83
6"	GUH20C1-6.0	6-53/64"	20'/25'/100'	200	29	20"	5.50



texcelindustrial.com

800.231.7116

WARNING: Cancer and Reproductive Harm  
www.P65Warnings.ca.gov





# TEX-PUSH-ON 300

300psi Push-On Hose

Low pressure braided hose for quick and easy insertion of push-on fittings with no special crimping tools required. Its internal polyester reinforcement design allows for excellent coupling retention. Tube handles oil-laden air, lubricating oils, mild alkalis or caustic solutions, fuel oil, and other petroleum-based products.



## TECHNICAL DATA

Tube	Black, NBR (ARPM Class A)
Cover	Black, Red, Blue NBR/PVC (ARPM Class A)
Reinforcement	Reinforced braided polyester cords
Safety Factor	4:1
Temperature	-40°F to +212°F (-40°C to +100°C)
Branding	TEXCEL® TEX-PUSH-ON <ID>
Packaging	1pc Reel

Dash	I.D.		#	Part Number	O.D.		Working Pressure		Burst Pressure		Weight	
	Inch	Dn			Inch	mm	psi	bar	psi	bar	lbs/ft	Kg/mt
4	¼	6		PUSH-4-250*	½	13	300	21	1200	83	0.10	0.15
5	5/16	8		PUSH-5-250*	14/25	14.33	300	21	1200	83	0.12	0.18
6	3/8	10		PUSH-6-250*	33/50	17	300	21	1200	83	0.14	0.20
8	½	12		PUSH-8-250*	81/100	21	300	21	1200	83	0.19	0.28
10	5/8	16		PUSH-10-250*	47/50	24	300	21	1200	83	0.22	0.33
12	¾"	19		PUSH-12-250*	1-9/100	28	300	21	1200	83	0.28	0.43
16	1	25		PUSH-16-250*	1-2/5	35.5	250	17	1000	69	0.46	0.68

\* For color variations of Blue, Red or Gray, add color name to the end of the part number, for example: PUSH-4-250-RED. Note: PUSH-5-250-BLUE is only available in Blue Cover.

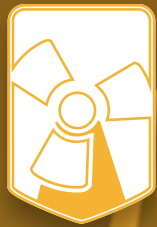

## TEX-MP

### Multi-Purpose Air Hose

Excellent quality multi-purpose hose for applications calling for oil resistance and higher working pressures. Tube handles oil-laden air, lubricating oils and mild alkalis or caustic solutions.



#### TECHNICAL DATA

Tube	Black, NBR (ARPM Class B)
Cover	Red, NBR/PVC (ARPM Class C)
Reinforcement	Braided polyester cords
Safety Factor	3:1
Temperature	-20°F to +180°F
Branding	TEXCEL® TEX-MP - MULTI-PURPOSE AIR HOSE -<ID>-XXX PSI WP-LOT

On 1/2" – 1" sizes that cannot be made to 600', but are ordered at 600', we will produce 2 – 300' lengths. 1-1/4" X 300' Reels will be made using 2- 150' lengths. 1-1/2" x 250' Reels will be made using a 100' length + a 150' length. There will be no more than 3 pieces per reel and there will never be a piece that is shorter than 50'

I.D.	Package Type	Part Number	O.D.	Std. Length	Working Pressure (psi)	Lbs./Ft.
1/4"	Reel	MP-4-R300-600R	3 <sup>9</sup> / <sub>64</sub> "	600'	300	0.13
3/8"	Reel	MP-6-R300-600R	4 <sup>6</sup> / <sub>64</sub> "	600'	300	0.22
1/2"	Reel	MP-8-R300-600R	5 <sup>6</sup> / <sub>64</sub> "	600'	300	0.31
3/4"	Reel	MP-12-R300-600R	1-1 <sup>4</sup> / <sub>64</sub> "	600'	300	0.48
1"	Reel	MP-16-R300-400R	1-2 <sup>8</sup> / <sub>64</sub> "	400'	300	0.66
1-1/4"	Reel	MP-20-R300-300R	1-4 <sup>8</sup> / <sub>64</sub> "	300'	300	0.69
1-1/2"	Reel	MP-24-R300-250R	2"	250'	300	0.80
2"	Reel	MP-32-R250-200R	2-3 <sup>8</sup> / <sub>64</sub> "	200'	250	1.54

## TEX-MP MAX

### Non-Conductive Multi-Purpose Air Hose

Premium quality multi-purpose hose for applications calling for maximum oil resistance and higher working pressures. Tube handles oil-laden air, lubricating oils, mild alkalis or caustic solutions, fuel oil, and other petroleum-based products. Non-Conductive construction makes it suitable for applications where electrical exposure and contact with high voltage may be encountered.



#### TECHNICAL DATA

Tube	Black, NBR (ARPM Class A)
Cover	Red, NBR/PVC (ARPM Class A)
Reinforcement	Braided polyester cords
Safety Factor	3:1
Temperature	-20°F to +180°F
Branding	TEXCEL® MP MAX - NON-CONDUCTIVE MULTI-PURPOSE HOSE -<ID INCH>-300PSI WP (2.07MPa) -LOT

On 1/2" – 1" sizes that cannot be made to 600', but are ordered at 600', we will produce 2 – 300' lengths. 1-1/4" X 300' Reels will be made using 2- 150' lengths. 1-1/2" x 250' Reels will be made using a 100' length + a 150' length. There will be no more than 3 pieces per reel and there will never be a piece that is shorter than 50'

**Maximum Length Per Size**  
 1/4" – 3/8" = 600'  
 1/2" – 1" = 500'  
 1-1/4" – 2" = 200'

I.D.	Package Type	Part Number	O.D.	Std. Length	Working Pressure (psi)	Lbs./Ft.
1/4"	Reel	MP-MAX-4-R300-600R	3 <sup>9</sup> / <sub>64</sub> "	600'	300	0.13
3/8"	Reel	MP-MAX-6-R300-600R	4 <sup>6</sup> / <sub>64</sub> "	600'	300	0.22
1/2"	Reel	MP-MAX-8-R300-600R	5 <sup>6</sup> / <sub>64</sub> "	600'	300	0.31
3/4"	Reel	MP-MAX-12-R300-600R	1-1 <sup>4</sup> / <sub>64</sub> "	600'	300	0.48
1"	Reel	MP-MAX-16-R300-400R	1-2 <sup>8</sup> / <sub>64</sub> "	400'	300	0.66
1-1/4"	Reel	MP-MAX-20-R300-300R	1-4 <sup>8</sup> / <sub>64</sub> "	300'	300	0.69
1-1/2"	Reel	MP-MAX-24-R300-250R	2"	250'	300	0.80
2"	Reel	MP-MAX-32-R250-200R	2-3 <sup>8</sup> / <sub>64</sub> "	200'	250	1.54





# TEX-CONTRACTORS

## Banded Contractor's Assembly

A tough, heavy-duty, abrasion and ozone-resistant general service hose coupled with plated, universal fittings secured with two galvanized steel Band-It® bands on each end.



### TECHNICAL DATA

Tube	Black, EPDM
Cover	Red, SBR/EPDM
Reinforcement	Braided polyester cords
Safety Factor	3:1
Temperature	-20°F to +180°F
Branding	TEXCEL® TEX-GS - GENERAL SERVICE AIR AND WATER -<ID>-XXXPSI WP-LOT
Couplings	Plated universal couplings with two galvanized steel Band-It® bands on each end
Packaging	Shrink-wrapped coils

Contractor's Air Assembly	I.D.	Number of Bands	Part Number	O.D.	Std. Length	Hose Working Pressure (psi)	Lbs./Assembly
50' Air Hose with	¾"	2	CON-12-300-50R2	1-12/64"	50'	300	22
Crow's Feet	1"	2	CON-16-300-50R2	1-24/64"	50'	300	30



# TEX-CRIMP CONTRACTORS

## Crimped Contractor's Assembly

A tough, heavy-duty, abrasion and ozone-resistant general service hose. Couplings are secured with a crimp ferrule.



### TECHNICAL DATA

Tube	Black, EPDM
Cover	Red, SBR/EPDM
Reinforcement	Braided polyester cords
Safety Factor	3:1
Temperature	-20°F to +180°F
Branding	TEXCEL® TEX-GS - GENERAL SERVICE AIR AND WATER -<ID>-XXXPSI WP-LOT
Couplings	Plated universal coupling with crimped ferrules
Packaging	Shrink-wrapped coils

Contractor's Air Assembly	I.D.	Part Number	O.D.	Std. Length	Hose Working Pressure (psi)	Lbs./Assembly
50' Air Hose	¾"	CON-12-300-50RC	1-12/64"	50'	300	22
with Crow's Feet	1"	CON-16-300-50RC	1-24/64"	50'	300	30

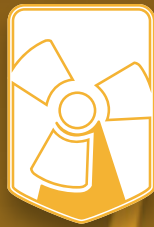

# TEX-MASTER

Heavy-Duty Textile Reinforced Air Hose

Heavy-duty, multi-purpose, textile reinforced hose for service where a tough and rugged hose is required.



## TECHNICAL DATA

Tube	Black, Nitrile blend	
Cover	Yellow, EPDM/SBR blend	
Reinforcement	High tensile tire cord plies	
Safety Factor	4:1	
Temperature	-40°F to +220°F	
Branding	TEXCEL® TEX-MASTER - HIGH TENSILE AIR HOSE 300 PSI W.P.	

I.D.	#	O.D.	Std. Length	Working Pressure (psi)	Lbs./Ft.
2"	MASTER-2.0	2-38/64"	100'	300	1.10
2-1/2"	MASTER-2.5	3-12/64"	100'	300	1.37
3"	MASTER-3.0	3-45/64"	100'	300	2.05
4"	MASTER-4.0	4-46/64"	100'	300	3.23

# TEX-KING

Wire Air Hose

The ideal "bull hose" for heavy construction, mining and road-building service. Braided steel wire construction.



## TECHNICAL DATA

Tube	Black, Nitrile/SBR blend	
Cover	Bright yellow, SBR blend (Pinpricked)	
Reinforcement	Steel braided wire plies	
Safety Factor	4:1	
Temperature	-22°F to +185°F, intermittent at 250°F	
Branding	TEXCEL® TEX-KING - STEEL WIRE AIR HOSE -<ID>- XXXPSI MAX WP(embossed)	

I.D.	#	O.D.	Std. Length	Working Pressure (psi)	Lbs./Ft.
1/2"	KING-.50	57/64"	100'	1000	0.31
3/4"	KING-.75	1-9/64"	100'	1000	0.44
1"	KING-1.0	1-27/64"	100'	800	0.61
1-1/2"	KING-1.5	1-62/64"	100'	800	1.07
2"	KING-2.0	2-33/64"	100'	600	1.44
2-1/2"	KING-2.5	3-5/64"	100'	600	1.41
3"	KING-3.0	3-40/64"	100'	500	2.19
4"	KING-4.0	4-51/64"	100'	500	4.55

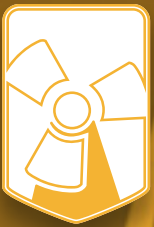





# TEX-STEAM

Steam Hose

Rugged, wire-braid steam hose recommended for saturated and super-heated steam applications in chemical plants, shipyards and industrial plants.



## TECHNICAL DATA

Tube	Black or red heat-resistant EPDM
Cover	Black, EPDM (pinpricked) Red, EPDM (pinpricked) *Red available in .75 x 50 only
Reinforcement	High tensile steel wires
Safety Factor	10:1
Temperature	-40°F to 410°F for saturated steam -40°F to 450°F for superheated
Branding	TEXCEL TEX-STEAM WIRE BRAID STEAM HOSE – 250PSI AT 450F/SATURATED STEAM 410F – DO NOT ALTERNATE STEAM AND WATER – DRAIN AFTER USE (embossed)
Safety Note	Drain the hose after each use for maximum hose life Do not alternate use between steam and water

Texcel recommends using Dixon Valve and Coupling's Crimp Boss™ Steam Fittings for black cover Tex-Steam hose or Boss™ 4-Bolt Clamp System for black and red Tex-STEAM hose. Please consult Dixon for proper coupling procedures.

I.D.	Part Number	O.D.	Std. Length	Working Pressure (psi)	Bend Radius	Lbs./Ft.
1/2"	STEAM-.50	60/64"	50'	250	3"	0.37
3/4"	STEAM-.75	1-16/64"	50'	250	4"	0.57
1"	STEAM-1.0	1-32/64"	50'	250	6"	0.70
1-1/2"	STEAM-1.5	2-4/64"	50'/100'	250	8"	1.10
2"	STEAM-2.0	2-44/64"	50'	250	10"	1.50
2-1/2"	STEAM-2.5	3-14/64"	100'	250	11"	2.29
3"	STEAM-3.0	3-50/64"	100'	250	13-1/2"	2.85

# TEX-GS

General Service Air & Water Hose

A tough, heavy-duty, abrasion and ozone-resistant general service hose. Designed for the transfer of air, mild chemicals and water across multiple applications. The ability to order this product in continuous lengths provides efficiently in inventory controls as well as ease of handling at job sites.



## TECHNICAL DATA

Tube	Black, EPDM
Cover	Red, SBR/EPDM
Reinforcement	One or two braided polyester cords
Safety Factor	3:1
Temperature	-20°F to +180°F
Branding	TEXCEL® TEX-GS - GENERAL SERVICE AIR AND WATER -<ID>-XXXPSI WP-LOT (white letters)
Packaging	Coils are continuous lengths

I.D.	Package Type	Part Number	O.D.	Std. Length	Working Pressure (psi)	Lbs./Ft.
1/4"	Reel	GS-4-R300-600R	33/64"	600'	300	0.12
	Coil	GS-4-C300-200R	33/64"	200'	300	0.12
5/16"	Reel	GS-5-R300-600R	38/64"	600'	300	0.15
	Coil	GS-5-C300-200R	38/64"	200'	300	0.15
3/8"	Reel	GS-6-R300-600R	43/64"	600'	300	0.19
	Coil	GS-6-C300-200R	43/64"	200'	300	0.19
1/2"	Reel	GS-8-R300-600R	53/64"	600'	300	0.26
	Coil	GS-8-C300-200R	53/64"	200'	300	0.26
5/8"	Reel	GS-10-R300-600R	63/64"	600'	300	0.33
	Reel	GS-12-R300-600R	1-9/64"	600'	300	0.45
3/4"	Coil	GS-12-C300-50R	1-9/64"	50'	300	0.45
	Coil	GS-12-C300-200R	1-9/64"	200'	300	0.45
1"	Reel	GS-16-R300-400R	1-27/64"	400'	300	0.60
	Coil	GS-16-C300-50R	1-27/64"	50'	300	0.60
1-1/4"	Reel	GS-20-R300-300R	1-47/64"	300'	300	0.86
1-1/2"	Reel	GS-24-R300-250R	2-8/64"	250'	300	1.37
2"	Reel	GS-32-R300-200R	2-39/64"	200'	300	1.61



On 1/2" – 1" sizes that cannot be made to 600', but are ordered at 600', we will produce 2 – 300' lengths. 1-1/4" X 300' Reels will be made using 2- 150' lengths. 1-1/2" x 250' Reels will be made using a 100' length + a 150' length. There will be no more than 3 pieces per reel and there will never be a piece that is shorter than 50'



# SIGMA-POLY-U™

Lightweight Polyurethane Hose

Extremely flexible hose, ideal for leaf collection, mulch blowing, straw blowing, wood chips, saw dust, lawn cleaning and concrete surface preparation equipment. The smooth bore polyurethane tube allows for high abrasion resistance and unrestricted flow.



## TECHNICAL DATA

Construction	Clear, polyurethane (ether-based) with exposed orange, rigid PVC, right-handed helix
Safety Factor	3:1
Temperature	-4°F to +150°F
Branding	TEXCEL® SIGMA-POLY U™ -LIGHTWEIGHT POLYURETHANE HOSE -<ID>-LOT
Compared To	Urevac-1/150 UDH
Safety Note	Service temperature depends on actual application

I.D.	#	O.D.	Std. Length	Working Pressure (psi)	Vacuum (in./HG)	Bend Radius	Lbs./Ft.
1-½"	SPVC-PU-1.5	1.91"	50'	20	22	1"	0.23
2"	SPVC-PU-2.0	2.46"	50'	15	21	1.5"	0.32
2-½"	SPVC-PU-2.5	3.01"	50'	9	19	1.5"	0.34
3"	SPVC-PU-3.0	3.60"	50'	8	19	2.5"	0.48
4"	SPVC-PU-4.0	4.72"	50'/100'	7	13	3"	0.70
5"	SPVC-PU-5.0	5.94"	50'/100'	6	10	4"	0.89
6"	SPVC-PU-6.0	7.17"	50'	5	7	5"	1.15
8"	SPVC-PU-8.0	9.33"	50'	3	5	7"	1.65

# SIGMA-ULTRAVAC-SBR™

SBR Vacuum Hose

Ultravac SBR™ is a specially compounded vacuum hose that is suitable for use in a multitude of wet and dry material applications. Being lightweight and flexible, Ultravac SBR™ is the ideal hose for vacuum trucks, hydro-excavators, and sewer cleaning equipment. Its static dissipative carbon black tube makes it suitable for handling sand, gravel, dry cement, iron chips, grains and other light abrasives.



## TECHNICAL DATA

Construction	Static dissipating, SBR blended tube with a rigid right-handed PVC helix
Safety Factor	3:1
Temperature	-40°F to +158°F
Branding	SIGMA SERIES - ULTRAVAC SBR-<ID>-LOT
Compared To	180 AR
Features	Excellent flexibility when compared to PVC/polyurethane hose

I.D.	#	O.D.	Std. Length	Working Pressure (psi)	Vacuum (in./HG)	Bend Radius	Lbs./Ft.
1 ½"	SP-SBR-1.5	1.82"	100'	45	29	2"	0.35
2"	SP-SBR-2.0	2.35"	100'	40	29	3"	0.52
2 ½"	SP-SBR-2.5	2.95"	100'	35	29	3"	0.90
3"	SP-SBR-3.0	3.5"	100'	35	29	3"	1.08
4"	SP-SBR-4.0	4.63"	50', 100'	30	29	5"	1.80
5"	SP-SBR-5.0	5.76"	50', 100'	30	28	5"	2.45
6"	SP-SBR-6.0	6.73"	50', 100'	30	28	9"	3.05
8"	SP-SBR-8.0	9.04"	50'	30	27	15"	5.63





# SIGMA-ULTRAVAC™

Polyurethane Vacuum Hose

Heavy-duty, abrasion-resistant suction hose for use in a variety of wet and dry, industrial vacuum applications including: vacuum trucks, hydro-excavators, sewer cleaners, street sweepers. SIGMA-ULTRAVAC™ is ideal for handling a wide range of materials, such as crushed rock, sand, pea gravel, dry-cement, grains and slurries. Made of with a permanently conductive tube that remains flexible at low temperatures for ease of handling.



## TECHNICAL DATA

Construction	Smooth permanently conductive, high abrasion resistant, polyurethane liner with a black, specially formulated polymer and a rigid PVC right-handed helix
Safety Factor	3:1
Temperature	-40°F to +158°F
Branding	TEXCEL® SIGMA-ULTRAVAC™ - POLYURETHANE SUCTION HOSE -<ID>-LOT
Safety Note	NOT recommended for constant contact with fuels or petroleum products  Service temperature depends on actual application
Compared To	ARVAC-SW
Features	Superior flexibility at low temperatures

I.D.	Part Number	O.D.	Std. Length	Working Pressure (psi)	Vacuum (in./HG)	Bend Radius	Lbs./Ft.
2"	SP-VAC-2.0-100	2-36/64"	100'	30	29	2"	0.74
3"	SP-VAC-3.0-100	3-38/64"	100'	30	29	3"	1.11
4"	SP-VAC-4.0-100	4-47/64"	100'	30	29	4"	1.80
5"	SP-VAC-5.0-100	5-33/64"	100'	30	27	6"	2.32
6"	SP-VAC-6.0-100	6-49/64"	100'	15	27	8"	2.86
8"	SP-VAC-8.0-50	8-7/8"	50'	15	27	14"	4.27



texcelindustrial.com

800.231.7116



# SIGMA-URE-B™

Polyurethane Material Handling Hose with PVC Cover

Abrasion-resistant, polyurethane tube for material handling in dry applications, such as sandblast recovery lines, roof rock cleaning and other abrasive applications. Made of static-dissipating material that remains flexible at low temperatures for ease of handling.



## TECHNICAL DATA

Construction	Black, flexible PVC and smooth with black, rigid, right-handed helix and smooth, polyurethane liner
Safety Factor	3:1
Temperature	-40°F to +150°F
Compared To	UBK
Safety Note	Service temperature depends on actual application

I.D.	Part Number	O.D.	Std. Length	Working Pressure (psi)	Vacuum (in./HG)	Bend Radius	Lbs./Ft.
2"	SPVC-URE-B-2.0	2.40"	50'/100'	40	29	2"	0.51
2-1/2"	SPVC-URE-B-2.5	3.10"	50'/100'	40	29	4"	0.77
3"	SPVC-URE-B-3.0	3.55"	50'/100'	40	29	4"	0.87
4"	SPVC-URE-B-4.0	4.68"	50'/100'	35	29	6"	1.55
5"	SPVC-URE-B-5.0	5.71"	50'/100'	30	28	10"	2.30
6"	SPVC-URE-B-6.0	7.05"	20'/50'/100'	30	28	12"	3.40
8"	SPVC-URE-B-8.0	9.05"	20'/50'	30	28	15"	4.88

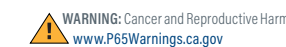

texcelindustrial.com

800.231.7116





# SIGMA-URE HD BLUE™

Heavy-Duty Polyurethane Material Handling Hose

Premium-quality, material handling hose designed with a thick, heavy-duty, smooth polyurethane lining. Ideal for dry applications where high abrasion resistance is required, as well as flexibility in sub-zero temperatures.



## TECHNICAL DATA

Construction	Clear, thick, heavy-duty, smooth, polyurethane lining with a blue, HMW PVC, formulated for static dissipation and a rigid PVC, right-handed helix	
Safety Factor	3:1	
Temperature	-40°F to +150°F	
Branding	TEXCEL® SIGMA-URE-HD BLUE™ - HEAVY DUTY MATERIAL HANDLING HOSE -<ID>-LOT	
Compared To	Ureflex-2	
Safety Note	Flexibility in sub-zero temperature Service temperature depends on actual application	

# GAMMA™-HTA

Hot Tar and Asphalt Hose

This rugged hose is specifically designed for the transfer of petroleum-based products such as high temperature asphalt, tar, and hot oils. Suitable for suction and discharge service on rail transport cars, tank trucks, bulk stations, storage tanks and disposing units.



## TECHNICAL DATA

Tube	Black, special synthetic acrylic rubber, heat and abrasion resistant	
Cover	Black, CR anti-static, with a smooth abrasion, weather and heat resistant wrapped cover	
Reinforcement	High tensile tire cord plies; dual helix wire	
Safety Factor	4:1	
Temperature	-20°F to +350°F (intermittent)	
Branding	TEXCEL® GAMMA™-HTA - HOT TAR & ASPHALT HOSE 150 PSI W.P.	
Safety Note	Texcel recommends using Dixon Valve and Coupling's Boss™ 4-Bolt Clamp System for Hot Tar and Asphalt hose. Please consult Dixon's selection and installation recommendations, including bolt re-tightening procedures, to insure proper hose assembly.  Maximum service temp. 350°F, intermittent use only	

I.D.	# Part Number	O.D.	Std. Length	Working Pressure (psi)	Vacuum (in./HG)	Bend Radius	Lbs./Ft.
2"	SPVC-URE-HD-2.0	2.43"	100'	40	29	4"	0.59
3"	SPVC-URE-HD-3.0	3.70"	100'	40	29	6"	1.23
4"	SPVC-URE-HD-4.0	4.80"	100'	35	29	10"	2.02
5"	SPVC-URE-HD-5.0	5.80"	20'/50'/100'	35	28	15"	2.57
6"	SPVC-URE-HD-6.0	6.87"	20'/50'/100'	30	28	18"	3.84

I.D.	# Part Number	O.D.	Std. Length	Working Pressure (psi)	Vacuum (in./HG)	Bend Radius	Lbs./Ft.
2"	GHTA15S1-2.0	2-46/64"	100'/200'	150	29	10"	1.80
3"	GHTA15S1-3.0	3-59/64"	100'/200'	150	29	15"	2.94
4"	GHTA15S1-4.0	4-51/64"	100'/200'	150	29	20"	3.89





# GAMMA™-HEAT

## Hot Air Blower Hose

High heat-resisting EPDM blower hose made with premium-grade materials for reliable service life when connecting the blower to flow lines on dry-bulk trailers.



### TECHNICAL DATA

Tube	Black, high heat-resisting EPDM	
Cover	Black or brown*, smooth high heat-resisting EPDM	
Reinforcement	High tensile tire cord plies; dual helix wire	
Safety Factor	4:1	
Temperature	-40°F to +300°F continuous; 350°F intermittent	
Branding	TEXCEL® GAMMA™ - HEAT - HOT AIR BLOWER HOSE 150 PSI W.P.	

\*The material code defaults to a brown cover. To order the black cover insert the letter B before hyphen in part number

I.D.	#	O.D.	Std. Length	Bend Radius	Working Pressure (psi)	Vacuum (in./HG)	Lbs./Ft.
3"	GHE15S1-3.0	3-33/64"	100'/200'	12"	150	29	1.75
4"	GHE15S1-4.0	4-39/64"	100'/200'	16"	150	29	2.40

# GAMMA™-BULK

## Dry Bulk Material Discharge Hose

Soft-wall discharge hose used in the transfer of dry materials and slurries. Ideal for dry cement, pebble lime and other abrasive media.



### TECHNICAL DATA

Tube	Black, abrasion-resistant NR/SBR, static-dissipating materials	
Cover	Black, abrasion-resistant NR/SBR	
Reinforcement	High tensile tire cord plies	
Safety Factor	4:1	
Temperature	-40°F to +180°F	
Branding	TEXCEL® GAMMA™-BULK - DRY CEMENT DISCHARGE HOSE STATIC CONDUCTIVE XX TUBE 75 PSI W.P.	

I.D.	#	Tube Gauge	O.D.	Std. Length	Working Pressure (psi)	Number of Plies	Lbs./Ft.
4"	GBU75S1B-4-4	1/8"	4-28/64"	100'	75	2	1.72
	GBU75S1B-4-6	3/16"	4-40/64"	100'	75	2	2.20
	GBU75S1B-4-8	1/4"	4-51/64"	100'	75	2	2.61
	GBU75S1B-4-12	3/8"	5-3/64"	100'	75	2	2.96
5"	GBU75S1B-5-4	1/8"	5-30/64"	100'	75	2	2.27
	GBU75S1B-5-6	3/16"	5-40/64"	100'	75	2	2.75
	GBU75S1B-5-8	1/4"	5-51/64"	100'	75	2	3.25





# TEX-BLAST

Sandblast Hose

Used with grit, aluminum oxide, glass beads, etc., and is ideal for rugged use in shipyards and construction sites.



## TECHNICAL DATA

Tube	Black, SBR/GUM, wear-resistant, static-dissipating materials
Cover	Black, SBR (pinpricked)
Reinforcement	High tensile tire cord plies
Safety Factor	4:1
Temperature	-40°F to +190°F
Branding	TEXCEL® TEX-BLAST - PREMIUM GRADE SANDBLAST HOSE 150 PSI W.P.

I.D.	Part Number	O.D.	Std. Length	Working Pressure (psi)	Fabric Plies	Lbs./Ft.
1/2"	BLAST-.50	1-9/64"	50'	150	2	0.40
3/4"	BLAST-.75	1-32/64"	50'	150	4	0.57
1"	BLAST-1.0	1-56/64"	50'	150	4	0.94
1-1/4"	BLAST-1.25	2-8/64"	50'	150	4	1.18
1-1/2"	BLAST-1.50	2-24/64"	50'/100'	150	4	1.35

# GAMMA™-COMM DISCHARGE

Commodity Discharge Hose

Soft-wall hose designed with a high abrasion-resistant tube. Ideal for applications where the discharging of wet or dry abrasive media is required.



## TECHNICAL DATA

Tube	Black, abrasion-resistant NR/SBR, static-dissipating materials
Cover	Black, SBR
Reinforcement	High tensile tire cord plies
Safety Factor	4:1
Temperature	-40°F to +180°F
Branding	TEXCEL® GAMMA™-COMM DISCH - BULK COMMODITY DISCHARGE HOSE STATIC CONDUCTIVE TUBE XXX PSI W.P.



I.D.	Part Number	O.D.	Tube Gauge	Std. Length	Working Pressure (psi)	Number of Plies	Lbs./Ft.
2"	GCOMM-D-B1-2.0	2-45/64"	3/16"	100'	150	2	1.51
2-1/2"	GCOMM-D-B1-2.5	3-13/64"	3/16"	100'	125	2	1.82
3"	GCOMM-D-B1-3.0	3-49/64"	3/16"	100'	125	2	2.20
4"	GCOMM-D-B1-4.0	4-45/64"	3/16"	100'	100	2	2.79
4-1/2"	GCOMM-D-B1-4.5	5-13/64"	1/4"	100'	75	2	3.40
5"	GCOMM-D-B1-5.0	5-45/64"	1/4"	100'	75	2	3.78
6"	GCOMM-D-B1-6.0	6-45/64"	1/4"	100'	75	2	4.06





# GAMMA™-BLACK COMM

Black Commodity Suction Hose

A hose similar to our renowned "TEX-COMMODITY" green suction hose, but with a black cover and tube, made of static-dissipating materials where food and potable water features are not necessary.



## TECHNICAL DATA

Tube	Black, abrasion-resistant NR/SBR, static-dissipating materials	
Cover	Black, SBR	
Reinforcement	High tensile tire cord plies; dual helix on sizes 2"-4"; single helix on sizes 5"-12"	
Safety Factor	4:1	
Temperature	-20°F to +180°F	
Branding	TEXCEL® GAMMA™-BLACK COMM - BULK COMMODITY SUCTION HOSE STATIC CONDUCTIVE TUBE XXX PSI W.P.	
Features	Size 5"-12" are corrugated for extra flexibility	

I.D.	#	O.D.	Tube Gauge	Std. Length	Working Pressure (psi)	Vacuum (in./HG)	Bend Radius	Lbs./Ft.
2"	GCOMM-S-B1-2.0	2-51/64"	3/16"	100'	150	28	5"	1.87
2-1/2"	GCOMM-S-B1-2.5	3-27/64"	3/16"	100'	125	28	8"	2.26
3"	GCOMM-S-B1-3.0	3-59/64"	3/16"	100'	125	28	10.5"	2.64
4"	GCOMM-S-B1-4.0	4-63/64"	3/16"	100'	100	28	12"	4.02
5"	GCOMM-S-B1-5.0	6-4/64"	1/4"	50'	75	28	13.5"	5.18
6"	GCOMM-S-B1-6.0	7-8/64"	1/4"	50'	75	25	15"	6.43
8"	GCOMM-S-B1-8.0	9-1/64"	1/4"	50'	50	20	17"	9.89
10"	GCOMM-S-B1-10.0	11-19/64"	1/4"	25'	50	20	19"	13.79
12"	GCOMM-S-B1-12.0	13-15/64"	1/4"	25'	50	20	25"	17.41

# TEX-COMMODITY

FDA Commodity Hose

The "original Green Monster", TEX-COMMODITY is the premier material handling hose in the industry. Suitable for abrasive materials, wet or dry. Also used for foodstuffs, flour, plastic pellets, etc. Ideal for sandblast return operations. Tube meets FDA requirements for food and potable water.



## TECHNICAL DATA

Tube	White, natural gum rubber	
Cover	Green, SBR	
Reinforcement	High tensile tire cord plies; dual helix on sizes 2"-4"; single helix on sizes 5"-12"	
Safety Factor	4:1	
Temperature	-40°F to +190°F	
Branding	TEXCEL® TEX-COMMODITY - FDA COMMODITY HOSE XXX PSI W.P.	
Features	Size 5"-12" are corrugated for extra flexibility Meets FDA requirements Superior abrasion resistance	

I.D.	#	O.D.	Tube Gauge	Std. Length	Working Pressure (psi)	Vacuum (in./HG)	Bend Radius	Lbs./Ft.
2"	COMM-2.0	2-54/64"	1/4"	100'	150	29	5"	2.60
2-1/2"	COMM-2.5	3-26/64"	1/4"	100'	150	29	8"	3.10
3"	COMM-3.0	3-56/64"	1/4"	100'	150	29	10.5"	3.62
4"	COMM-4.0	4-60/64"	1/4"	100'	100	29	12"	5.57
5"	COMM-5.0	5-60/64"	1/4"	50'	75	28	13.5"	7.00
6"	COMM-6.0	6-59/64"	5/16"	50'	50	25	15"	7.25
8"	COMM-8.0	9-6/64"	3/8"	50'	50	20	17"	10.80
10"	COMM-10.0	11-20/64"	3/8"	25'	50	20	19"	15.10
12"	COMM-12.0	13-28/64"	3/8"	25'	50	20	25"	18.20





# TEX-ELEPHANT

Elephant Trunk Hose

Premium-quality hose made with 1/8" tube gauge for high abrasion and cut resistance. Ideal for cement and abrasives gravity flow, and for use in sleeve applications.



## TECHNICAL DATA

Tube	Tan, pure gum	
Cover	Black, NR/SBR compound	
Reinforcement	High tensile synthetic plies	
Safety Factor	3:1	
Temperature	-20°F to +180°F	
Branding	TEXCEL™ TEX-ELEPHANT - ELEPHANT TRUNK HOSE 50 PSI W.P.	

# TEX-DREDGE

Dredge Sleeve

A rugged, abrasion-resistant tube and cover for flexible connections between pipes used in dredging applications.



## TECHNICAL DATA

Tube	Black, 3/8", abrasion-resistant SBR compound	
Cover	Black, 3/32", weather and abrasion-resistant SBR	
Reinforcement	High tensile synthetic plies	
Safety Factor	3:1	
Temperature	-20°F to +180°F	

I.D.	Part Number	O.D.	Tube Gauge	Std. Length	Working Pressure (psi)	Lbs./Ft.
8"	ELEP-8.0	8-33/64"	1/8"	50'	50	3.84
10"	ELEP-10.0	10-33/64"	1/8"	50'	50	5.50
12"	ELEP-12.0	12-33/64"	1/8"	25'	50	6.00
14"	ELEP-14.0	14-33/64"	1/8"	25'	50	7.00
16"	ELEP-16.0	16-33/64"	1/8"	25'	50	8.15

I.D.	Part Number	O.D.	Tube Gauge	Std. Length	Working Pressure (psi)	Lbs./Ft.
6-5/8"	DREDGE-6	8-39/64"	3/8"	50'	125	6.59
8-5/8"	DREDGE-8	10-42/64"	3/8"	50'	125	9.23
10-3/4"	DREDGE-10	12"	3/8"	30'	125	10.98
12-3/4"	DREDGE-12	14-3/64"	3/8"	30'	125	13.24







# GAMMA™-WIRE CRETE

Wire Concrete Placement Hose

A heavy-duty hose designed to handle the most abrasive applications and weather conditions. Suitable for handling wet concrete in areas where flex is critical. Ideal for use on high pressure concrete pumps or boom trucks where a tough, durable hose is required for high pressure concrete pumping and placing applications.



## TECHNICAL DATA

Tube	Black, wear-resistant, GUM/SBR blend	
Cover	Black, SBR, cut and gouge-resistant	
Reinforcement	Multiple steel wire plies	
Safety Factor	2:1 (per ASME standards)	
Temperature	-40°F to +200°F	
Branding	TEXCEL GAMMA™ SERIES CONCRETE PLACEMENT HOSE – WIRE XX" 1450 PSI (100 BAR) WP XXLBS/FT (F.W.C.) MEETS OR EXCEEDS ASME B30.27-2009	
Features	Meets ASME B3.27-2009 specifications	

I.D.	#	O.D.	Std. Length	Working Pressure psi/bar	Burst Pressure psi/bar	Bend Radius	Lbs./Ft.
2"	GWC12S1-2.0	2-48/64"	100'	1450/100	2900/200	12"	1.86
2-1/2"	GWC12S1-2.5	3-24/64"	100'	1450/100	2900/200	16"	2.67
3"	GWC12S1-3.0	3-60/64"	100'	1450/100	2900/200	18"	3.37
4"	GWC12S1-4.0	5-4/64"	100'	1450/100	2900/200	24"	5.31
5"	GWC12S1-5.0	6-8/64"	50'	1450/100	2900/200	30"	6.57

# TEX-CRETE

Textile Concrete Hose

Designed to provide the ultimate combination of handling ease, abuse resistance and long service life required for plaster, grout and concrete placement applications. Ideal for concrete pumping applications.



## TECHNICAL DATA

Tube	Black, wear-resistant, GUM/SBR blend	
Cover	Black, SBR, cut and gouge-resistant	
Reinforcement	Multiple plies of high tensile tire cord	
Safety Factor	2:1 (per ASME standards)	
Temperature	-40°F to +200°F	
Branding	TEXCEL® TEX-CRETE - FABRIC CONCRETE PLACEMENT HOSE 1230 PSI (85 BAR) W.P. XXX LBS/FT (F.W.C)	
Features	Meets ASME B3.27-2009 specifications	

I.D.	#	O.D.	Std. Length	Working Pressure psi/bar	Burst Pressure psi/bar	Bend Radius	Lbs./Ft.
1-1/4"	CRETE-1.25	2"	100'	1230/85	2460/170	8"	0.86
1-1/2"	CRETE-1.5	2-12/64"	100'	1230/85	2460/170	10"	0.92
2"	CRETE-2.0	2-49/64"	50'/100'	1230/85	2460/170	12"	1.45
2-1/2"	CRETE-2.5	3-22/64"	100'	1230/85	2460/170	14"	1.71
3"	CRETE-3.0	4"	50'/100'	1230/85	2460/170	15"	2.40
3-1/2"	CRETE-3.5	4-31/64"	100'	1230/85	2460/170	16"	3.07
4"	CRETE-4.0	5-10/64"	100'	1230/85	2460/170	18"	4.06
4-1/2"	CRETE-4.5	5-38/64"	100'	1230/85	2460/170	21"	4.22
5"	CRETE-5.0	6-19/64"	100'	1230/85	2460/170	24"	5.60
6"	CRETE-6.0	7-21/64"	100'	1230/85	2460/170	30"	6.80





# SIGMA-DUTY MAX™

NBR Suction Hose

Duty Max is a heavy-duty, all-weather, suction hose for use in liquid manure handling, septic and wastewater handling, water suction, and general oilfield applications. Please note that service life may vary based on media being conveyed and operating conditions. The PVC helix makes for increased toughness over rough surfaces and around corners making it the perfect product for harsh conditions.



## TECHNICAL DATA

Construction	NBR/PVC tube with a PVC helix
Safety Factor	3:1
Temperature	-40°F to +140°F (-40°C to +60°C)
Features	Superior flexibility even at sub-zero temperatures Lightweight, with floating capabilities

I.D.	Part Number	O.D.	Std. Length	Working Pressure (psi)	Vacuum (in./HG)	Bend Radius	Lbs./Ft.
1-½"	SP-DUTY-1.5-100	1.82"	100'	50	29.8	3.0"	0.44
2"	SP-DUTY-2.0-100*	2.43"	100'	50	29.8	5.0"	0.74
3"	SP-DUTY-3.0-100*	3.55"	100'	43	29.8	7.0"	1.21
4"	SP-DUTY-4.0-100*	4.62"	100'	38	29.8	11.0"	1.95
6"	SP-DUTY-6.0-100	6.81"	20'/100'	23	28.0	20.0"	3.23

\* For color variations of Blue and Yellow, add color name before the size, for example: SP-DUTY-BLUE-2.0-100



texcelindustrial.com

800.231.7116



## Hose System Pressure Derating Multipliers For Elevated Temperatures (°F)

Hose Type	Steam, Hot Tar, Asphalt	PVC	All Other
70°	1.00	1.00	1.00
90°	0.95	0.82	0.91
150°	0.81	0.32	0.64
200°	0.68	N/R	0.42
250°	0.56	N/R	0.20
300°	0.44	N/R	N/R
350°	0.32	N/R	N/R
400°	0.20	N/R	N/R
450°	0.08	N/R	N/R
500°	N/R	N/R	N/R



texcelindustrial.com

800.231.7116





\*Special order items only.

# GROWLER™

Brewery Hose

GROWLER™ brewery hose is a heavy-duty hose formulated for the suction and delivery of beer, wine, alcohol, and soft drinks. The GROWLER™ hose has a white, smooth BIIR (butyl) rubber tube to ensure food quality and is odorless and does not alter taste. Its high working temperature allows for the sterilization of the hose with steam at 230°F for 30 minutes. Meets FDA title 21 part.177.2600(e) for liquid foods, BfR, ADI free, EC 1935 / 2004.



## TECHNICAL DATA

Tube	White, BIIR (BUTYL)
Cover	Orange, EPDM
Reinforcement	High strength synthetic plies with steel helix
Safety Factor	3:1
Temperature	-40°F to +248°F
Branding	TEXCEL® GROWLER™ BREWERS HOSE 150PSI (10 BAR) W.P. TEMP. -40F TO 248F (-40C TO 120C) STERILIZATION AT 230F FOR 30 MINS FDA BFR ADI FREE
Safety Note	It is recommended that all food grade hose be thoroughly flushed prior to initial use
Features	FDA, USDA compliant



I.D.	Part Number	O.D.	Std. Length	Working Pressure (psi)	Vacuum (in./HG)	Bend Radius	Lbs./Ft.
3/4"	GRLR-.75-100	1 1/4"	100'	150	29	1.5"	0.48
1"	GRLR-1.0-100	1 29/64"	100'	150	29	1.75"	0.58
1-1/4"	GRLR-1.25-100	1 47/64"	100'	150	29	3"	0.74
1-1/2"	GRLR-1.5-100	1 62/64"	100'	150	29	4"	0.97
2"	GRLR-2.0-100	2 33/64"	100'	150	29	6"	1.26

# BALTHAZAR™ PLUS

Winery Hose

BALTHAZAR™ Plus winery hose is a smooth covered hose formulated for the suction and delivery of wine, fruit juice, and soft drinks. The BALTHAZAR™ Plus hose has a white, smooth Butyl tube to ensure food quality and is odorless and does not alter taste. Its high working temperature allows for the sterilization of the hose with steam at 230°F for 30 minutes. Meets FDA title 21 part.177.2600(e) for liquid foods, BfR, ADI free, EC 1935 / 2004.



## TECHNICAL DATA

Tube	White, Butyl
Cover	Gray, EPDM
Reinforcement	High strength synthetic plies with polyethylene spiral helix
Safety Factor	3:1
Temperature	-30°F to +220 °F
Branding	TEXCEL® BALTHAZAR™ PLUS WINERY HOSE 250 PSI (17BAR)
W.P. TEMP.	-30F TO +220F (-34C TO 104C) STERILIZATION AT 230F FOR 30 MINS FDA BFR ADI FREE
Safety Note	It is recommended that all food grade hose be thoroughly flushed prior to initial use
Features	FDA, USDA compliant

I.D.	Part Number	O.D.	Std. Length	Working Pressure (psi)	Vacuum (in./HG)	Bend Radius	Lbs./Ft.
1-1/2"	BZAR-1.5-100	2 1/4"	100'	250	29	5"	0.93
2"	BZAR-2.0-100	2 49/64"	100'	250	29	9"	1.26
3"	BZAR-3.0-100	3 52/64"	100'	250	29	10"	2.02





# DAIRY-KING™

Milk Hose

DAIRY-KING™ milk hose is specifically designed for the suction and delivery of milk and other fatty foods. The DAIRY-KING™ hose has a white, smooth, NBR rubber tube to ensure product quality, is odorless and does not alter taste. Its blue, smooth, cloth impression EPDM rubber cover offers abrasion-, ozone- and weather-resistance. This hose can be sterilized with steam at 230°F for 30 minutes. Meets FDA title 21 part.177.2600(f) for fatty foods, BfR, ADI free, D.M. 21/03/73, EC 1935 / 2004. Hose conform to 3A standards.



## TECHNICAL DATA

Tube	White, NBR	
Cover	Blue, EPDM	
Reinforcement	High strength synthetic plies with steel helix	
Safety Factor	3:1	
Temperature	-40°F to +248°F	
Branding	TEXCEL® DAIRY-KING™ MILK HOSE 150 PSI (10 BAR) W.P. TEMP. -40F TO 248F (-40C TO 120C) STERILIZATION AT 230F FOR 30 MINS FDA BFR ADI FREE	
Safety Note	It is recommended that all food grade hose be thoroughly flushed prior to initial use	
Features	FDA, USDA and 3A compliant	

\*Special order items only.



# ELIXIR™

Distillery Hose

ELIXIR™ distillery hose is specially formulated for the suction and delivery of alcohols up to 96%, wine, beer, potable water, and other related foodstuffs. The ELIXIR™ hose has a clear, UHMWPE tube to ensure food quality and is both odorless and does not alter taste. Its higher working temperature allows for it to be sterilized with steam at 230°F for 30 minutes. Meets FDA title 21 part.177.2600(e) for liquid foods, BfR, KTW, EC 1935 / 2004.



## TECHNICAL DATA

Tube	Clear, UHMWPE	
Cover	Green, EPDM	
Reinforcement	High strength synthetic plies with steel helix	
Safety Factor	3:1	
Temperature	-40°F to +230°F	
Branding	TEXCEL® ELIXIR™ DISTILLERY HOSE 150 PSI (10 BAR) W.P. TEMP. -4F TO 230F (-20C TO 100C) STERILIZATION AT 230F FOR 30 MINS FDA BFR KTW	
Safety Note	It is recommended that all food grade hose be thoroughly flushed prior to initial use	
Features	FDA, USDA compliant	

I.D.	Part Number	O.D.	Std. Length	Working Pressure (psi)	Vacuum (in./HG)	Bend Radius	Lbs./Ft.
¾"	MILK-.75-100	1 ¼"	100'	150	29	2.5"	0.45
1"	MILK-1.0-100	1 ¼"	100'	150	29	3.5"	0.54
1-¼"	MILK-1.25-100	1 ¾"	100'	150	29	4.25"	0.83
1-½"	MILK-1.5-100	1 ¾"	100'	150	29	5"	0.93
2"	MILK-2.0-100	2 ¼"	100'	150	29	7.5"	1.26
2-½"	MILK-2.5-100	3 ¼"	100'	150	29	9"	1.75
3"	MILK-3.0-100	3 ¾"	100'	150	29	11"	2.02
4"	MILK-4.0-100	4 ¾"	100'	150	29	13"	3.09

I.D.	Part Number	O.D.	Std. Length	Working Pressure (psi)	Vacuum (in./HG)	Bend Radius	Lbs./Ft.
¾"	ELIX-.75-100	1 ¼"	100'	150	29	2.5"	0.48
½"	ELIX-.50-100	5/8"	100'	150	29	2"	0.39
1"	ELIX-1.0-100	1 ¼"	100'	150	29	3.5"	0.58
1-¼"	ELIX-1.25-100	1 ¾"	100'	150	29	4.25"	0.72
1-½"	ELIX-1.5-100	2"	100'	150	29	5"	0.91
2"	ELIX-2.0-100	2 ¼"	100'	150	29	7.5"	1.54
2-½"	ELIX-2.5-100	3 ¼"	100'	150	29	9"	1.69
3"	ELIX-3.0-100	3 ¾"	100'	150	29	11"	2.07
4"	ELIX-4.0-100	4 ¾"	100'	150	29	13"	3.03



# SIGMA-LT-BLUE™

FDA PVC Low Temp Suction Hose

Heavy-duty, low-temp, blue, food-grade suction hose for wet material applications. Hose complies with applicable FDA and 3A requirements as well as USDA for use in dairy plants. Clear PVC and blue helix construction allows for visual confirmation of material flow. Smooth bore eliminates material build up. Hose remains flexible in sub-zero temperatures.



## TECHNICAL DATA

Construction	Clear, flexible FDA PVC with smooth tube and cover, flexible in extreme cold.
Safety Factor	3:1
Temperature	-40°F to +150°F
Branding	TEXCEL® SIGMA-LT-BLUE™ - LOW TEMP BLUE FOOD GRADE SUCTION HOSE -<ID>-LOT
Safety Note	It is recommended that all food grade hose be thoroughly flushed prior to initial use
Features	FDA, USDA and 3A compliant. Phthalate Free

I.D.	Part Number	O.D.	Std. Length	Working Pressure (psi)	Vacuum (in./HG)	Bend Radius	Lbs./Ft.
¾"	SPVC-LT-BLUE-.75	1.01"	100'	90	29	2.5"	0.19
1"	SPVC-LT-BLUE-1.0	1.25"	100'	90	29	3"	0.22
1-¼"	SPVC-LT-BLUE-1.25	1.56"	100'	90	29	4"	0.36
1-½"	SPVC-LT-BLUE-1.5	1.77"	100'	90	29	5"	0.45
2"	SPVC-LT-BLUE-2.0	2.36"	100'	90	29	7"	0.62
2-½"	SPVC-LT-BLUE-2.5	2.90"	100'	70	29	8"	0.87
3"	SPVC-LT-BLUE-3.0	3.42"	100'	65	29	10"	1.20
4"	SPVC-LT-BLUE-4.0	4.50"	100'	55	29	15"	1.83
5"	SPVC-LT-BLUE-5.0	5.59"	100'	45	28	25"	2.42
6"	SPVC-LT-BLUE-6.0	6.70"	100'	40	28	30"	3.36

# SIGMA-FDW™

FDA PVC Grounded Food-Grade Suction Hose

Heavy-duty, food-grade suction hose with embedded copper grounding wire for dry/wet material applications. Hose complies with applicable FDA and 3A requirements as well as USDA for use in meat and poultry plants. Clear PVC and clear helix construction allows for visual confirmation of material flow. Smooth bore eliminates material build up. Heavy corrugation provides high flexibility. Embedded wire prevents static electricity build up.



## TECHNICAL DATA

Construction	Corrugated, clear, flexible PVC with smooth bore and a rigid, clear PVC, right-handed helix with embedded copper wire for static dissipation
Safety Factor	3:1
Temperature	-4°F to +150°F
Branding	TEXCEL® SIGMA-FDW™ - GROUNDED FOOD GRADE SUCTION HOSE -<ID>-LOT
Compared To	WE/ST 200 SFG
Safety Note	It is recommended that all food grade hose be thoroughly flushed prior to initial use
Features	FDA, USDA and 3A compliant. Phthalate Free

I.D.	Part Number	O.D.	Std. Length	Working Pressure (psi)	Vacuum (in./HG)	Bend Radius	Lbs./Ft.
1-½"	SPVC-FDW-1.5	1.82"	100'	45	29	2.5"	0.44
2"	SPVC-FDW-2.0	2.35"	100'	40	29	3"	0.58
2-½"	SPVC-FDW-2.5	2.87"	100'	35	29	5"	0.75
3"	SPVC-FDW-3.0	3.50"	100'	35	29	6"	1.07
4"	SPVC-FDW-4.0	4.63"	100'	30	29	8"	1.52
5"	SPVC-FDW-5.0	5.63"	100'	30	25	10"	2.39
6"	SPVC-FDW-6.0	6.73"	100'	30	25	12"	3.12





# SIGMA-FD™

FDA PVC Food-Grade Suction Hose

Heavy-duty, food-grade suction hose for dry/wet material applications. Hose complies with applicable FDA and 3A requirements as well as USDA for use in meat and poultry plants. Clear PVC and clear helix construction allows for visual confirmation of material flow. Smooth bore eliminates material build up. Heavy corrugation provides high flexibility.



## TECHNICAL DATA

Construction	Corrugated, clear, flexible PVC with smooth bore and a rigid, clear PVC, right-handed helix
Safety Factor	3:1
Temperature	-4°F to +150°F
Branding	TEXCEL® SIGMA-FD™ - FOOD GRADE SUCTION HOSE -<ID>-LOT
Compared To	WT/200 SFG
Safety Note	Service temperature depends on actual application  It is recommended that all food grade hose be thoroughly flushed prior to initial use
Features	FDA, USDA and 3A compliant. Phthalate Free

I.D.	# Part Number	O.D.	Std. Length	Working Pressure (psi)	Vacuum (in./HG)	Bend Radius	Lbs./Ft.
1-1/2"	SPVC-FD-1.5	1.82"	100'	45	29	2.5"	0.35
2"	SPVC-FD-2.0	2.35"	100'	40	29	3"	0.50
2-1/2"	SPVC-FD-2.5	2.87"	100'	35	29	5"	0.68
3"	SPVC-FD-3.0	3.50"	100'	35	29	6"	1.00
4"	SPVC-FD-4.0	4.63"	100'	30	29	8"	1.52
6"	SPVC-FD-6.0	6.73"	100'	30	25	12"	3.05
8"	SPVC-FD-8.0	9.04"	20'	20	25	16"	5.32



# TEX-WASHDOWN

300PSI Washdown Hose

TEX-WASHDOWN hose is the perfect solution for conveying water up to 199°F (93°C) for washdown service in dairies, creameries, breweries, distilleries, meat packing facilities, and food processing plants. Its high-quality, white EPDM cover offers mild abrasion-, ozone-, and weather-resistance.



## TECHNICAL DATA

Tube	Black, EPDM
Cover	White, EPDM
Reinforcement	Braided polyester cords
Safety Factor	4:1
Temperature	-40°F to +199°F
Branding	TEXCEL® TEX-WASHDOWN 300 PSI (20 BAR) W.P. WASHDOWN HOSE TEMP. -40F TO 199F (-40C TO 92C) 4:1 SAFETY FACTOR
Safety Note	It is recommended that all food grade hose be thoroughly flushed prior to initial use

I.D.	# Part Number	O.D.	Std. Length	Working Pressure (psi)	Lbs./Ft.
1/2"	WASH-.5-300	58/64"	300'	300	0.25
3/4"	WASH-.75-300	1 17/64"	300'	300	0.39
1"	WASH-1.0-300	1 35/64"	300'	300	0.5



# TEX-SANITRANS

FDA Sanitary Discharge Hose

Tube and cover designed for discharge or transfer of food and potable water. Highly resistant to animal fat and vegetable oils.



## TECHNICAL DATA

Tube	White, Nitrile	
Cover	Gray Neoprene	
Reinforcement	High tensile strength tire cord plies	
Safety Factor	3:1	
Temperature	-22°F to +185°F	
Branding	TEXCEL® TEX-SANITRANS - SANITARY DISCHARGE HOSE 150 PSI W.P. MEETS FDA AND USDA	
Safety Note	It is recommended that all food grade hose be thoroughly flushed prior to initial use	
Features	FDA and USDA compliant	



# TEX-SANIVAC

FDA Sanitary Vacuum Hose

Tube and cover designed for suction, discharge or transfer of food and potable water. Highly resistant to animal fat and vegetable oils.



## TECHNICAL DATA

Tube	White, Nitrile	
Cover	White or gray Neoprene	
Reinforcement	High tensile strength tire cord plies; dual helix wire	
Safety Factor	3:1	
Temperature	-22°F to +185°F	
Packaging	Coiled, double wrapped, ends capped	
Branding	TEXCEL® TEX-SANIVAC - SANITARY SUCTION HOSE 150 PSI W.P. MEETS FDA AND USDA	
Safety Note	It is recommended that all food grade hose be thoroughly flushed prior to initial use	
Features	FDA and USDA compliant	



I.D.	Part Number	O.D.	Std. Length	Working Pressure (psi)	Lbs./Ft.
2"	SAND-2.0	2- <sup>25</sup> / <sub>64</sub> "	100'/200'	150	0.80
3"	SAND-3.0	3- <sup>28</sup> / <sub>64</sub> "	100'/200'	150	1.23
4"	SAND-4.0	4- <sup>28</sup> / <sub>64</sub> "	100'/200'	150	1.70

I.D.	Part Number	O.D.	Std. Length	Working Pressure (psi)	Vacuum (in./HG)	Bend Radius	Lbs./Ft.
1- <sup>1</sup> / <sub>2</sub> "	SANV-1.5	2- <sup>1</sup> / <sub>64</sub> "	100'/200'	150	29	3- <sup>3</sup> / <sub>4</sub> "	0.93
2"	SANV-2.0	2- <sup>33</sup> / <sub>64</sub> "	100'/200'	150	29	5"	1.20
2- <sup>1</sup> / <sub>2</sub> "	SANV-2.5	3- <sup>3</sup> / <sub>64</sub> "	100'/200'	150	29	6"	1.71
3"	SANV-3.0	3- <sup>35</sup> / <sub>64</sub> "	100'/200'	150	29	7"	2.09
4"	SANV-4.0	4- <sup>40</sup> / <sub>64</sub> "	100'/200'	150	29	9"	2.94





# CORNUCOPIA™

All-Purpose Sanitary Hose

CORNUCOPIA™ hose is a multipurpose sanitary hose. CORNUCOPIA™ is formulated for use with fatty foods, wine, beer, potable water, and other related foodstuffs. The white, smooth EPDM tube ensures food quality by being odorless and does not alter taste. The UHMWPE outer cover not only dramatically increases the abrasion resistance of the hose but is Antimicrobial and offers increased dragability. The high working temperature allows for the sterilization of the hose with steam at 230°F for 30 minutes. Meets FDA title 21 part. 177.2600(f) for fatty foods, BfR, ADI Free, D.M. 21/03/73, EC 1935 / 2004.



## TECHNICAL DATA

Tube	White, EPDM	
Cover	Red, EPDM with a clear UHMWPE wrap	
Reinforcement	High strength synthetic plies with steel helix	
Safety Factor	3:1	
Temperature	-40°F to +284°F	
Branding	TEXCEL® CORNUCOPIA™ ALL PURPOSE SANITARY HOSE 150 PSI (10 BAR) W.P. UHMW COVER TEMP. -40F TO 284F (-40C to 140C) FDA BfR D.M.21/03/73 ADI FREE STERILIZATION at 230F FOR 30 MINS	
Safety Note	It is recommended that all food grade hose be thoroughly flushed prior to initial use	
Features	FDA and USDA compliant  UHMWPE abrasion-resistant, Antimicrobial cover	

\*Special order items only.

# SIGMA-POLY MHH™

Polyurethane Food-Grade Suction & Discharge Hose

Heavy-duty construction that complies with all applicable FDA requirements. Clear polyurethane and blue PVC helix construction allows for visual confirmation of material flow. Smooth bore construction eliminates material build up. Yarn reinforced for discharge applications. Heavy corrugation provides extra flexibility. Embedded wire prevents static electricity build up.



## TECHNICAL DATA

Construction	Clear, flexible polyurethane with a blue, tough vinyl right-handed helix; synthetic yarn reinforcement, embedded copper wire for grounding; static wire
Safety Factor	3:1
Temperature	-40°F to +150°F
Branding	TEXCEL® SIGMA-PVC MHH™ - POLYURETHANE FOOD GRADE SUCTION / DISCHARGE HOSE -<ID>-LOT
Safety Note	Grounding wire must be properly terminated at both ends in order to dissipate static electricity  It is recommended that all food grade hose be thoroughly flushed prior to initial use
Features	FDA and USDA compliant, Phthalate Free

I.D.	# Part Number	O.D.	Std. Length	Working Pressure (psi)	Vacuum (in./HG)	Bend Radius	Lbs./Ft.
1"	FDA-1.0-100	1 24/64"	100'	150	29	3.5"	0.54
1-1/4"*	FDA-1.25-100	1 47/64"	100'	150	29	4.25"	0.83
1-1/2"	FDA-1.5--100	1 62/64"	100'	150	29	5"	0.93
2"	FDA-2.0-100	2 32/64"	100'	150	29	7.5"	1.26
2-1/2"*	FDA-2.5-100	3 2/64"	100'	150	29	9"	1.75
3"	FDA-3.0-100	3 32/64"	100'	150	29	11"	2.02
4"	FDA-4.0-100	4 36/64"	100'	150	29	13"	3.09

I.D.	# Part Number	O.D.	Std. Length	Working Pressure (psi)	Vacuum (in./HG)	Bend Radius	Lbs./Ft.
3"	SPVC-MHH-3.0	3.78"	100'	100	29	10"	1.18
4"	SPVC-MHH-4.0	4.85"	100'	75	29	12"	1.58
5"	SPVC-MHH-5.0	5.80"	20'/50'/100'	70	28	14"	2.47
6"	SPVC-MHH-6.0	6.93"	20'/50'/100'	70	28	14"	2.86







# TEX-STEAM™ FDA

Food Grade Steam Hose

TEX-STEAM™ FDA is a specially-compounded steam hose. It is suitable for the delivery of potable hot water mixed with steam and detergents. The main use is for washdown and sterilization in the food industry and manufacturing plants. TEX-STEAM™ FDA has a white, smooth, food quality EPDM rubber tube and a blue, smooth, cloth-impression EPDM rubber cover for abrasion-, ozone-, and weather-resistance. Meets FDA title 21, part.177.2600 for aqueous foods.

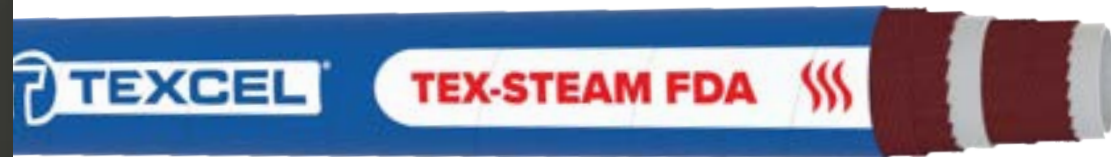

## TECHNICAL DATA

Tube	White, EPDM
Cover	Blue, EPDM
Reinforcement	High strength synthetic plies
Safety Factor	10:1
Temperature	-40°F to 338°F
Branding	TEXCEL® TEX-STEAM™ FDA STEAM HOSE 105 PSI (7 BAR) W.P TEMP. -40F TO 338F (-40C to 170C) 10:1 SAFETY FACTOR
Safety Note	Drain the hose after each use for maximum hose life  Do not alternate use between steam and water  Texcel recommends using Dixon Valve and Coupling's Boss™ Stainless Steel Ground Joint and 4-Bolt System for Tex-STEAM™ FDA. Please consult Dixon for proper coupling procedures.  It is recommended that all food grade hose be thoroughly flushed prior to initial use
Features	FDA and USDA compliant

I.D.	Part Number	O.D.	Std. Length	Working Pressure (psi)	Lbs./Ft.
1/2"	STFD-.5-100	60/64"	100	105	0.25
3/4"	STFD-.75-100	1 14/64"	100	105	0.39
1"	STFD-1.0-100	1 29/64"	100	105	0.5

## SATURATED (NOT SUPER-HEATED) STEAM WARNING

Steam heat is hotter than 212°F and increases in temperature as pressure increases.

Consult with your coupling manufacturer to make sure the correct fittings are used for the application and for guidelines on proper assembly techniques.

If not controlled properly, exposure to steam can be hazardous and could cause serious injury or even death. In order to avoid serious injury or death, proper hose selection, installation, usage and maintenance is necessary.



texcelindustrial.com

800.231.7116



# FDA-BULK

Food Grade Dry Material Discharge Hose

Soft Wall hose for dry and abrasive food stuffs such as grains, rice, sugar, flour and animal foods. Meets FDA title 21, part.177.2600 for dry foods, BfR, ADI free, phthalate free, D.M. 21/03/73, CE 1935/2004



## TECHNICAL DATA

Tube	White, smooth NR rubber compound, food quality odorless and taste free
Cover	Gray, smooth, cloth impressions NR/SBR rubber compound, resistant to abrasion and weather
Reinforcement	High strength synthetic plies, with stranded copper wire for hose grounding
Safety Factor	3:1
Temperature	-40°F to +176°F Sterilization at 230°F for 30 minutes
Branding	TEXCEL® FDA-BULK - FOOD GRADE DRY MATERIAL DISCHARGE HOSE 1/8 TUBE 150 PSI W.P.



I.D.	Part Number	Tube Gauge	O.D.	Std. Length	Working Pressure (psi)	Number of Plies	Lbs./Ft.
4"	FDABULK-4-4-100	1/8"	4-29/64"	100'	150	2	1.63



texcelindustrial.com

800.231.7116





# FDA-HEAT

## FDA Hot Air Blower Hose

Suction and delivery hose for hot dry air in FDA tanker hauling. FDA title 21 part.177.2600 (a,b,c,d) for dry foods.



### TECHNICAL DATA

Tube	White, Smooth EPDM rubber compound, food quality odorless and taste free
Cover	Blue, cloth impression EPDM rubber, resistant to abrasion, ozone and weather 
Reinforcement	High strength synthetic plies with single steel wire helix
Safety Factor	3:1
Temperature	-40°F to +350°F
Branding	TEXCEL® FDA - HEAT - FDA HOT AIR BLOWER HOSE 150 PSI W.P.

I.D.	Part Number	O.D.	Std. Length	Bend Radius	Working Pressure (psi)	Vacuum (in./HG)	Lbs./Ft.
3"	FDAHEAT-3.0-100	3- <sup>35</sup> / <sub>64</sub> "	100'	12"	150	29	1.85

### CERTIFICATIONS & AGENCIES

FDA	The Food & Drug Administration
FDA title 21 part.177.2600	This is a regulation that the FDA puts out regarding polymers that come in contact with food meant for human consumption. Section 177.2600, paragraph E, mentions that the food-contact surface of the rubber article when extracted with distilled water at reflux temperature, shall yield total extractives not to exceed 20 milligrams per square inch during the first 7 hours of extraction, nor to exceed 1 milligram per square inch during the succeeding 2 hours of extraction.
BfR	Bundesinstitut für Risikobewertung, the German version of the FDA that outlines how polymers should be used in the manufacturing process so that polymers do not endanger human health.
D.M. 21 / 03 / 73	This stands for "Decree of the Minister of Health of 21 March 1973". An Italian Regulation that deals with polymers that come in contact with food stuffs, mainly aqueous, oily or fatty foods.
ADI Free	Free of any Animal-Derived Ingredients
Wine Glass & Fork Symbol	The international symbol for "food safe" material. The symbol identifies that material used in the product are safe for food contact. It is used in North America, Europe and Asia but is now mandatory in Europe after Framework Regulation EC 1935 / 2004.
EC 1935 / 2004	EC means the European Community a.k.a., the European Commission. This regulation is from the European Parliament and of the Council of 27 October 2004 on materials and articles intended to come into contact with food.
KTW	The German agency for water and gas, Deutsche Vereinigung des Gas -und Wasserfaches, defines a series of recommendations for materials coming in contact with water.

### Compliance Information:

3A	Material approved by 3A Sanitary Standards, Inc. for multi-use plastic materials, number: 20-25, as product contact surfaces in equipment for production, processing and handling of milk and dairy products.
BSE/TSE	The majority of the raw materials used in formulations are not manufactured or derived from materials of animal origin. Nor do products come into contact with materials of animal origin during processing. Suppliers of raw materials have assured that their compounds exceed the relevant European Guidance on minimizing the Risk of Transmitting Animal Spongiform Encephalopathy Agents Via Human and Veterinary Medical Products.
FDA	Material conforms to CFR title 21, parts 170-199.
RoHS	The product complies with the requirements of the EU directive <sup>2002</sup> / <sub>95</sub> /EC which is on the restriction of the use of certain hazardous substances in electrical and electronic equipment.
USDA	Hose approved by the US Department of Agriculture for use in federally inspected meat and poultry plants.



## CERTIFICATIONS & AGENCIES



# COUPLINGS

TEX-QD, Quick Disconnect Fittings	100
TEX-QD-HD, Quick Disconnect Fittings	101
TEX-RHS, Round Hole Strainers	102
SIGMA-CLAMP™, Double Bolt Spiral Clamp	103
SIGMA-COIL™, Banding Coil	104
CAM & GROOVE COUPLING LINE, Type A Adapter	105
CAM & GROOVE COUPLING LINE, Type B Coupler	106
CAM & GROOVE COUPLING LINE, Type C Coupler	107
CAM & GROOVE COUPLING LINE, Type D Coupler	108
CAM & GROOVE COUPLING LINE, Type E Coupler	109
CAM & GROOVE COUPLING LINE, Type F Adapter	110
CAM & GROOVE COUPLING LINE, Type Dust Cap	111
CAM & GROOVE COUPLING LINE, Type Dust Plug	112
FERRULE	113
KC-NIP, KC NIPPLE	114
MALE PIPE, MALE PIPE THREAD CRIMP	115
SLEEVE	116
FLANGES	117
MALE ADAPTERS, Spool Adapter (Male X Male)	118
FEMALE ADAPTERS, Double Female Adapter (Female X Female)	119
REDUCING ADAPTERS, Coupler X Adapter - Reducing (Female X Male)	120
BLAST FITTING, Sandblast Coupling	121
UNIVERSAL, Universal Crowfoot	122

# TEX-QD

## Quick Disconnect Fittings

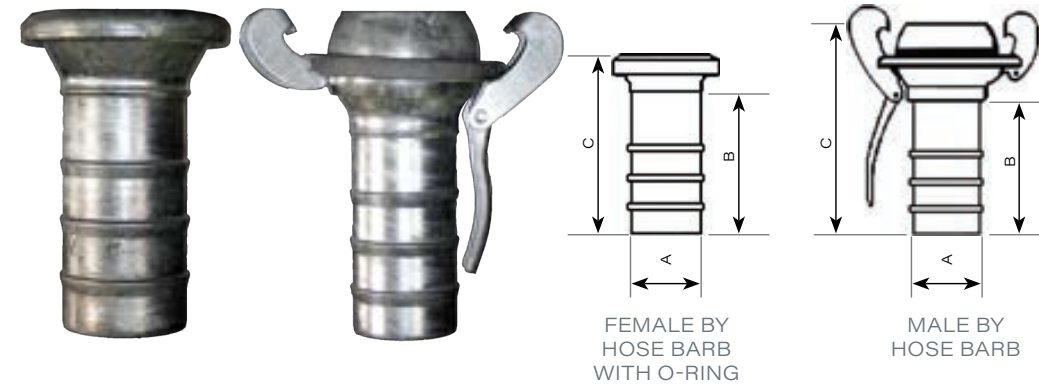

FEMALE BY HOSE BARB WITH O-RING

MALE BY HOSE BARB

### FEMALE BY HOSE BARB WITH O-RING:

I.D.	Part Number	A Dim.	B Dim.	C Dim.	Lbs./Each
2"	2.0-QDF-SP	2.0"	3.75"	5.25"	0.75
3"	3.0-QDF-SP	3.0"	5.25"	7.0"	1.75
4"	4.0-QDF-SP	4.0"	8.0"	10.5"	3.30
6"	6.0-QDF-SP	6.0"	8.5"	10.5"	6.40
8"	8.0-QDF-SP	7-58/64"	9.25"	13"	12.70
<b>With Locking Lever Welded On</b>					
10"	10.0-QDF-SP	9-56/64"	11.5"	15.75"	28.00
12"	12.0-QDF-SP	11-56/64"	11.5"	16.5"	39.00

### MALE BY HOSE BARB:

I.D.	Part Number	A Dim.	B Dim.	C Dim.	Lbs./Each
<b>With Locking Lever Welded On</b>					
2"	2.0-QDM-SP	2.0"	3.75"	6.25"	1.65
3"	3.0-QDM-SP	3.0"	5.25"	8.25"	3.35
4"	4.0-QDM-SP	4.0"	8.0"	12.5"	7.10
6"	6.0-QDM-SP	6.0"	8.5"	12.5"	14.15
8"	8.0-QDM-SP	7-58/64"	9.25"	15.0"	21.15
<b>Lever Welded on Female End</b>					
10"	10.0-QDM-SP	9-56/64"	11.5"	15.75"	25.0
12"	12.0-QDM-SP	11-56/64"	11.5"	6.5"	35.0



## TEX-QD-HD

Quick Disconnect Fittings



### FEMALE BY HOSE BARB WITH O-RING:

I.D.	Part Number	A Dim.	B Dim.	C Dim.	Lbs./Each
4"	4.0-QDF-HD-SP	4.0"	8.0"	10.5"	4
6"	6.0-QDF-HD-SP	6.0"	8.5"	10.5"	10
8"	8.0-QDF-HD-SP	7-5/8"	9.25"	13"	15

### MALE BY HOSE BARB:

I.D.	Part Number	A Dim.	B Dim.	C Dim.	Lbs./Each
With Locking Lever Welded On					
4"	4.0-QDM-HD-SP	4.0"	8.0"	12.5"	8
6"	6.0-QDM-HD-SP	6.0"	8.5"	12.5"	17
8"	8.0-QDM-HD-SP	7-5/8"	9.25"	15.0"	26

## TEX-RHS

Round Hole Strainers

14 gauge zinc-plated strainer by female thread.

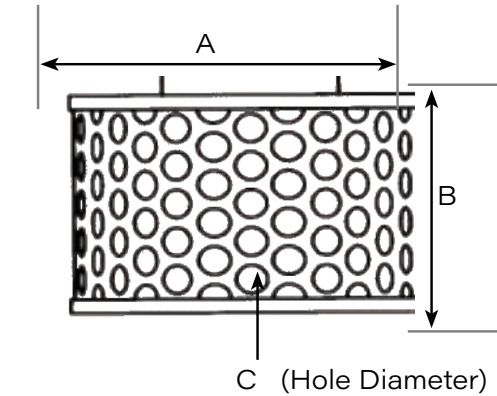

Female Thread Diameter	Part Number	A Dim.	B Dim.	C Dim.	Lbs./Each
1-1/2"	1.5-ROUND-STRAINER-SP	5.0"	4.25"	0.375"	1.20
2"	2.0-ROUND-STRAINER-SP	6.0"	4.5"	0.375"	1.65
2-1/2"	2.5-ROUND-STRAINER-SP	6.0"	4.5"	0.375"	1.85
3"	3.0-ROUND-STRAINER-SP	7.0"	5.625"	0.375"	2.35
4"	4.0-ROUND-STRAINER-SP	7.0"	5.75"	0.375"	2.45
6"	6.0-ROUND-STRAINER-SP	9.125"	9.25"	1.0"	5.70
8"	8.0-ROUND-STRAINER-SP	11.375"	11.25"	1.0"	9.95



## SIGMA-CLAMP™

Double Bolt Plated Steel Spiral Clamp

Double bolt plated steel spiral clamps are recommended for use with Texcel's Sigma-Series PVC hoses with convoluted cover.



	Hose Diameter	Part Number	Lbs./Each
Right Hand	1-½"	1.5-SP-CLAMP	0.29
	2"	2.0-SP-CLAMP	0.34
	2-½"	2.5-SP-CLAMP	0.63
	3"	3.0-SP-CLAMP	0.72
	4"	4.0-SP-CLAMP	1.21
	5"	5.0-SP-CLAMP	1.41
	6"	6.0-SP-CLAMP	2.29
	8"	8.0-SP-CLAMP	2.97
	10"	10.0-SP-CLAMP	3.55
	12"	12.0-SP-CLAMP	4.11
Left Hand	1-½"	1.5-SP-CLAMP-LH	0.29
	2"	2.0-SP-CLAMP-LH	0.34
	3"	3.0-SP-CLAMP-LH	0.72
	4"	4.0-SP-CLAMP-LH	1.21
	5"	5.0-SP-CLAMP-LH	1.41
	6"	6.0-SP-CLAMP-LH	2.29
	8"	8.0-SP-CLAMP-LH	2.97

## SIGMA-COIL™

Banding Coil

Use banding coils to level external corrugations, or when using sleeves or bands for increased surface area and improved compression and fitting retention. Each piece makes two hose ends (one hose assembly). Operator must cut into two pieces.



Hose Diameter	Part Number	In./Each	Lbs./Each
1-½"	1.5-SLINKY	2.75"	0.07
2"	2.0-SLINKY	3.0"	0.12
2-½"	2.5-SLINKY	3.25"	0.16
3"	3.0-SLINKY	3.5"	0.23
4"	4.0-SLINKY	3.75"	0.45
5"	5.0-SLINKY	6.0"	1.27
6"	6.0-SLINKY	8.0"	1.93
8"	8.0-SLINKY	8.5"	3.71





## CAM & GROOVE COUPLING LINE

### Type A Adapter

Aluminum Constructed Cam and Groove type A male adapter by female NPT. Also available in stainless steel and brass.



Hose Diameter	Part Number	Lbs./Each
¾"	.75-A-ALUM-SP	0.1
1"	1.0-A-ALUM-SP	0.14
1-¼"	1.25-A-ALUM-SP	0.22
1-½"	1.5-A-ALUM-SP	0.27
2"	2.0-A-ALUM-SP	0.31
2-½"	2.5-A-ALUM-SP	0.41
3"	3.0-A-ALUM-SP	0.59
4"	4.0-A-ALUM-SP	1.22
5"	5.0-A-ALUM-SP	2.09
6"	6.0-A-ALUM-SP	2.62
8"	8.0-A-ALUM-SP	8.5
¾"	.75-A-BRASS-SP	0.29
1"	1.0-A-BRASS-SP	0.38
1-¼"	1.25-A-BRASS-SP	0.59
1-½"	1.5-A-BRASS-SP	0.75
2"	2.0-A-BRASS-SP	1.1
2-½"	2.5-A-BRASS-SP	2.48
3"	3.0-A-BRASS-SP	2.09
4"	4.0-A-BRASS-SP	3.45

## CAM & GROOVE COUPLING LINE

### Type B Coupler

Aluminum Constructed Cam and Groove type B female coupler by male NPT. Also available in stainless steel and brass.



Hose Diameter	Part Number	Lbs./Each
¾"	.75-B-ALUM-SP	0.26
1"	1.0-B-ALUM-SP	0.44
1-¼"	1.25-B-ALUM-SP	0.66
1-½"	1.5-B-ALUM-SP	0.69
2"	2.0-B-ALUM-SP	0.85
2-½"	2.5-B-ALUM-SP	1
3"	3.0-B-ALUM-SP	1.65
4"	4.0-B-ALUM-SP	2.26
5"	5.0-B-ALUM-SP	2.64
6"	6.0-B-ALUM-SP	4.37
8"	8.0-B-ALUM-SP	15.66
¾"	.75-B-BRASS-SP	0.41
1"	1.0-B-BRASS-SP	0.64
1-¼"	1.25-B-BRASS-SP	1.1
1-½"	1.5-B-BRASS-SP	1.23
2"	2.0-B-BRASS-SP	1.43
2-½"	2.5-B-BRASS-SP	1.98
3"	3.0-B-BRASS-SP	2.88
4"	4.0-B-BRASS-SP	4.08





# CAM & GROOVE COUPLING LINE

## Type C Coupler

Aluminum Constructed Cam and Groove type C female coupler by hose shank. Also available in stainless steel and brass.



Hose Diameter	Part Number	Lbs./Each
3/4"	.75-C-ALUM-SP	0.26
1"	1.0-C-ALUM-SP	0.45
1-1/4"	1.25-C-ALUM-SP	0.70
1-1/2"	1.5-C-ALUM-SP	0.75
2"	2.0-C-ALUM-SP	1.04
2-1/2"	2.5-C-ALUM-SP	1.47
3"	3.0-C-ALUM-SP	2.04
4"	4.0-C-ALUM-SP	2.94
5"	5.0-C-ALUM-SP	3.37
6"	6.0-C-ALUM-SP	6.39
8"	8.0-C-ALUM-SP	13
3/4"	.75-C-BRASS-SP	0.46
1"	1.0-C-BRASS-SP	0.73
1-1/4"	1.25-C-BRASS-SP	1.15
1-1/2"	1.5-C-BRASS-SP	1.43
2"	2.0-C-BRASS-SP	1.91
2-1/2"	2.5-C-BRASS-SP	2.94
3"	3.0-C-BRASS-SP	3.58
4"	4.0-C-BRASS-SP	5.07
3/4"	.75-C-SS-SP	0.39
1	1.0-C-SS-SP	0.65
1-1/4"	1.25-C-SS-SP	1.02
1-1/2"	1.5-C-SS-SP	1.23
2	2.0-C-SS-SP	1.78
2-1/2"	2.5-C-SS-SP	2.77
3	3.0-C-SS-SP	3.4
4	4.0-C-SS-SP	5.89
5	5.0-C-SS-SP	7.25
6	6.0-C-SS-SP	11
2"	2.0-C-CS-SP	1.78
3"	3.0-C-CS-SP	3.88
4"	4.0-C-CS-SP	5.89

# CAM & GROOVE COUPLING LINE

## Type D Coupler

Aluminum Constructed Cam and Groove type D female coupler by female NPT. Also available in stainless steel and brass.



Hose Diameter	Part Number	Lbs./Each
3/4"	.75-D-ALUM-SP	0.26
1"	1.0-D-ALUM-SP	0.37
1-1/4"	1.25-D-ALUM-SP	0.77
1-1/2"	1.5-D-ALUM-SP	0.80
2"	2.0-D-ALUM-SP	0.88
2-1/2"	2.5-D-ALUM-SP	1
3"	3.0-D-ALUM-SP	1.75
4"	4.0-D-ALUM-SP	2.51
5"	5.0-D-ALUM-SP	3.51
6"	6.0-D-ALUM-SP	5.31
8"	8.0-D-ALUM-SP	11
3/4"	.75-D-BRASS-SP	0.44
1"	1.0-D-BRASS-SP	0.68
1-1/4"	1.25-D-BRASS-SP	1.14
1-1/2"	1.5-D-BRASS-SP	1.32
2"	2.0-D-BRASS-SP	1.54
2-1/2"	2.5-D-BRASS-SP	1.98
3"	3.0-D-BRASS-SP	3.06
4"	4.0-D-BRASS-SP	4.96
3/4"	.75-D-SS-SP	0.48
1"	1.0-D-SS-SP	0.81
1-1/4"	1.25-D-SS-SP	1.44
1-1/2"	1.5-D-SS-SP	1.50
2"	2.0-D-SS-SP	1.82
2-1/2"	2.5-D-SS-SP	2.54
3"	3.0-D-SS-SP	3.24
4"	4.0-D-SS-SP	5.18
5"	5.0-D-SS-SP	8.35
6"	6.0-D-SS-SP	8.42





## CAM & GROOVE COUPLING LINE

### Type E Coupler

Aluminum Constructed Cam and Groove type E male coupler by hose shank.  
Also available in stainless steel and brass.



Hose Diameter	Part Number	Lbs./Each
¾"	.75-E-ALUM-SP	0.13
1"	1.0-E-ALUM-SP	0.22
1-¼"	1.25-E-ALUM-SP	0.30
1-½"	1.5-E-ALUM-SP	0.39
2"	2.0-E-ALUM-SP	0.63
2-½"	2.5-E-ALUM-SP	0.89
3"	3.0-E-ALUM-SP	1.10
4"	4.0-E-ALUM-SP	2.11
5"	5.0-E-ALUM-SP	2.95
6"	6.0-E-ALUM-SP	6.25
8"	8.0-E-ALUM-SP	8.75
¾"	.75-E-BRASS-SP	0.36
1"	1.0-E-BRASS-SP	0.59
1-¼"	1.25-E-BRASS-SP	0.99
1-½"	1.5-E-BRASS-SP	1.24
2"	2.0-E-BRASS-SP	1.87
2-½"	2.5-E-BRASS-SP	2.69
3"	3.0-E-BRASS-SP	4
4"	4.0-E-BRASS-SP	6.34
¾"	.75-E-SS-SP	0.31
1"	1.0-E-SS-SP	0.51
1-¼"	1.25-E-SS-SP	0.9
1-½"	1.5-E-SS-SP	1.12
2"	2.0-E-SS-SP	1.65
2-½"	2.5-E-SS-SP	2.58
3"	3.0-E-SS-SP	3.55
4"	4.0-E-SS-SP	4.89
5"	5.0-E-SS-SP	6.11
6"	6.0-E-SS-SP	8.25
2"	2.0-E-CS-SP	1.67
3"	3.0-E-CS-SP	3.44
4"	4.0-E-CS-SP	4.89

## CAM & GROOVE COUPLING LINE

### Type F Adapter

Aluminum Constructed Cam and Groove type F male adapter by male NPT.  
Also available in stainless steel and brass.



Hose Diameter	Part Number	Lbs./Each
¾"	.75-F-ALUM-SP	0.17
1"	1.0-F-ALUM-SP	0.22
1-¼"	1.25-F-ALUM-SP	0.26
1-½"	1.5-F-ALUM-SP	0.40
2"	2.0-F-ALUM-SP	0.55
2-½"	2.5-F-ALUM-SP	0.97
3"	3.0-F-ALUM-SP	1.18
4"	4.0-F-ALUM-SP	2.02
5"	5.0-F-ALUM-SP	2.94
6"	6.0-F-ALUM-SP	3.98
8"	8.0-F-ALUM-SP	11.30
¾"	.75-F-BRASS-SP	0.41
1"	1.0-F-BRASS-SP	0.81
1-¼"	1.25-F-BRASS-SP	1.05
1-½"	1.5-F-BRASS-SP	1.27
2"	2.0-F-BRASS-SP	1.8
2-½"	2.5-F-BRASS-SP	2.2
3"	3.0-F-BRASS-SP	3.62
4"	4.0-F-BRASS-SP	6.39
¾"	.75-F-SS-SP	0.39
1"	1.0-F-SS-SP	0.78
1-¼"	1.25-F-SS-SP	0.98
1-½"	1.5-F-SS-SP	1.7
2"	2.0-F-SS-SP	1.75
2-½"	2.5-F-SS-SP	1.7
3"	3.0-F-SS-SP	3.55
4"	4.0-F-SS-SP	6.18
5"	5.0-F-SS-SP	8.22
6"	6.0-F-SS-SP	10.55







## CAM & GROOVE COUPLING LINE

### Type Dust Cap

Dust caps are the solution to seal a hose assembly when it is not under pressure during transfer or storage. The aluminum constructed dust cap is compatible with type A & E. Also available in stainless steel and brass.



Hose Diameter	Part Number	Lbs./Each
3/4"	.75-DC-ALUM-SP	0.21
1"	1.0-DC-ALUM-SP	0.44
1-1/4"	1.25-DC-ALUM-SP	0.62
1-1/2"	1.5-DC-ALUM-SP	0.69
2"	2.0-DC-ALUM-SP	0.79
2-1/2"	2.5-DC-ALUM-SP	1.19
3"	3.0-DC-ALUM-SP	1.57
4"	4.0-DC-ALUM-SP	2.2
5"	5.0-DC-ALUM-SP	3.02
6"	6.0-DC-ALUM-SP	3.95
8"	8.0-DC-ALUM-SP	8.82
3/4"	.75-DC-BRASS-SP	0.38
1"	1.0-DC-BRASS-SP	0.55
1-1/4"	1.25-DC-BRASS-SP	1.05
1-1/2"	1.5-DC-BRASS-SP	1.07
2"	2.0-DC-BRASS-SP	1.43
2-1/2"	2.5-DC-BRASS-SP	2.04
3"	3.0-DC-BRASS-SP	2.76
4"	4.0-DC-BRASS-SP	3.86
3/4"	.75-DC-SS-SP	0.35
1"	1.0-DC-SS-SP	0.51
1-1/4"	1.25-DC-SS-SP	0.98
1-1/2"	1.5-DC-SS-SP	1.01
2"	2.0-DC-SS-SP	1.33
2-1/2"	2.5-DC-SS-SP	1.95
3"	3.0-DC-SS-SP	2.55
4"	4.0-DC-SS-SP	3.56
5"	5.0-DC-SS-SP	4.12
6"	6.0-DC-SS-SP	6.33

## CAM & GROOVE COUPLING LINE

### Type Dust Plug

Dust plugs are the solution to seal a hose assembly when it is not under pressure during transfer or non-use. The aluminum constructed dust plug is compatible with type C & D. Also available in stainless steel and brass.



Hose Diameter	Part Number	Lbs./Each
3/4"	.75-DP-ALUM-SP	0.07
1"	1.0-DP-ALUM-SP	0.11
1-1/4"	1.25-DP-ALUM-SP	0.22
1-1/2"	1.5-DP-ALUM-SP	0.25
2"	2.0-DP-ALUM-SP	0.35
2-1/2"	2.5-DP-ALUM-SP	0.41
3"	3.0-DP-ALUM-SP	0.69
4"	4.0-DP-ALUM-SP	1.29
5"	5.0-DP-ALUM-SP	1.63
6"	6.0-DP-ALUM-SP	2.36
8"	8.0-DP-ALUM-SP	6.14
3/4"	.75-DP-BRASS-SP	0.17
1"	1.0-DP-BRASS-SP	0.3
1-1/4"	1.25-DP-BRASS-SP	0.61
1-1/2"	1.5-DP-BRASS-SP	0.75
2"	2.0-DP-BRASS-SP	1.19
2-1/2"	2.5-DP-BRASS-SP	1.71
3"	3.0-DP-BRASS-SP	2.2
4"	4.0-DP-BRASS-SP	3.67
3/4"	.75-DP-SS-SP	0.16
1"	1.0-DP-SS-SP	0.25
1-1/4"	1.25-DP-SS-SP	0.55
1-1/2"	1.5-DP-SS-SP	0.66
2"	2.0-DP-SS-SP	1.05
2-1/2"	2.5-DP-SS-SP	1.66
3"	3.0-DP-SS-SP	2.02
4"	4.0-DP-SS-SP	3.55
5"	5.0-DP-SS-SP	4.25
6"	6.0-DP-SS-SP	5.55





## FERRULE



Hose Diameter	Sleeve ID	Part Number
1"	1-32/64	1.0-CS-FERR-132-SP
1"	1-36/64	1.0-CS-FERR-136-SP
1"	1-40/64	1.0-CS-FERR-140-SP
1-1/4"	1-48/64	1.25-CS-FERR-148-SP
1-1/2"	2	1.5-CS-FERR-200-SP
1-1/2"	2-04/64	1.5-CS-FERR-204-SP
1-1/2"	2-08/64	1.5-CS-FERR-208-SP
2"	2-32/64	2.0-CS-FERR-232-SP
2"	2-36/64	2.0-CS-FERR-236-SP
2"	2-40/64	2.0-CS-FERR-240-SP
2"	2-44/64	2.0-CS-FERR-244-SP
2"	2-48/64	2.0-CS-FERR-248-SP
2"	2-52/64	2.0-CS-FERR-252-SP
2"	2-56/64	2.0-CS-FERR-256-SP
2-1/2"	3-08/64	2.5-CS-FERR-308-SP
2-1/2"	3-12/64	2.5-CS-FERR-312-SP
2-1/2"	3-16/64	2.5-CS-FERR-316-SP
2-1/2"	3-32/64	2.5-CS-FERR-332-SP
3"	3-36/64	3.0-CS-FERR-336-SP
3"	3-40/64	3.0-CS-FERR-340-SP
3"	3-44/64	3.0-CS-FERR-344-SP
3"	3-48/64	3.0-CS-FERR-348-SP
3"	3-52/64	3.0-CS-FERR-352-SP
3"	3-56/64	3.0-CS-FERR-356-SP
3"	3-60/64	3.0-CS-FERR-360-SP
3"	4	3.0-CS-FERR-400-SP
4"	4-36/64	4.0-CS-FERR-436-SP
4"	4-40/64	4.0-CS-FERR-440-SP
4"	4-44/64	4.0-CS-FERR-444-SP
4"	4-48/64	4.0-CS-FERR-448-SP
4"	4-52/64	4.0-CS-FERR-452-SP
4"	4-56/64	4.0-CS-FERR-456-SP
4"	4-60/64	4.0-CS-FERR-460-SP
4"	5	4.0-CS-FERR-500-SP
4"	5-04/64	4.0-CS-FERR-504-SP
6"	6-40/64	6.0-CS-FERR-640-SP
6"	6-48/64	6.0-CS-FERR-648-SP
6"	6-56/64	6.0-CS-FERR-656-SP
6"	7	6.0-CS-FERR-700-SP
6"	7-08/64	6.0-CS-FERR-708-SP
6"	7-24/64	6.0-CS-FERR-724-SP
8"	8-48/64	8.0-CS-FERR-848-SP
8"	9	8.0-CS-FERR-900-SP
8"	9-16/64	8.0-CS-FERR-916-SP
8"	9-32/64	8.0-CS-FERR-932-SP

## KC-NIP

KC NIPPLE



Hose Diameter	Part Number	Lbs./Each
3/4"	.75-KC-NIP-SP	0.18
1"	1.0-KC-NIP-SP	0.22
1-1/2"	1.5-KC-NIP-SP	0.25
2"	2.0-KC-NIP-SP	1.04
2-1/2"	2.5-KC-NIP-SP	1
3"	3.0-KC-NIP-SP	2.2
4"	4.0-KC-NIP-SP	3.97
5"	5.0-KC-NIP-SP	5.25
6"	6.0-KC-NIP-SP	8.82
8"	8.0-KC-NIP-SP	15
10"	10.0-KC-NIP-SP	18
12"	12.0-KC-NIP-SP	22





# MALE PIPE

## MALE PIPE THREAD CRIMP



Hose Diameter	Part Number	Lbs./Each
2"	2.0-CS-MNPT-CRIMP-SP	2.9
3"	3.0-CS-MNPT-CRIMP-SP	3.7
4"	4.0-CS-MNPT-CRIMP-SP	4.8
6"	6.0-CS-MNPT-CRIMP-SP	10.3

# SLEEVE



Hose Diameter	Sleeve ID	Part Number
2"	2- <sup>36</sup> / <sub>64</sub>	2.0-CS-SLEEVE-236-SP
2"	2- <sup>40</sup> / <sub>64</sub>	2.0-CS-SLEEVE-240-SP
2"	2- <sup>48</sup> / <sub>64</sub>	2.0-CS-SLEEVE-248-SP
3"	3- <sup>36</sup> / <sub>64</sub>	3.0-CS-SLEEVE-336-SP
3"	3- <sup>40</sup> / <sub>64</sub>	3.0-CS-SLEEVE-340-SP
3"	3- <sup>44</sup> / <sub>64</sub>	3.0-CS-SLEEVE-344-SP
3"	3- <sup>48</sup> / <sub>64</sub>	3.0-CS-SLEEVE-348-SP
3"	3- <sup>52</sup> / <sub>64</sub>	3.0-CS-SLEEVE-352-SP
3"	3- <sup>56</sup> / <sub>64</sub>	3.0-CS-SLEEVE-356-SP
4"	4- <sup>40</sup> / <sub>64</sub>	4.0-CS-SLEEVE-440-SP
4"	4- <sup>44</sup> / <sub>64</sub>	4.0-CS-SLEEVE-444-SP
4"	4- <sup>48</sup> / <sub>64</sub>	4.0-CS-SLEEVE-448-SP
4"	4- <sup>52</sup> / <sub>64</sub>	4.0-CS-SLEEVE-452-SP
4"	4- <sup>56</sup> / <sub>64</sub>	4.0-CS-SLEEVE-456-SP
4"	4- <sup>60</sup> / <sub>64</sub>	4.0-CS-SLEEVE-460-SP
5"	5- <sup>48</sup> / <sub>64</sub>	5.0-CS-SLEEVE-548-SP
5"	5- <sup>60</sup> / <sub>64</sub>	5.0-CS-SLEEVE-560-SP
6"	6- <sup>40</sup> / <sub>64</sub>	6.0-CS-SLEEVE-640-SP
6"	6- <sup>48</sup> / <sub>64</sub>	6.0-CS-SLEEVE-648-SP
6"	6- <sup>56</sup> / <sub>64</sub>	6.0-CS-SLEEVE-656-SP
6"	7	6.0-CS-SLEEVE-700-SP
6"	7- <sup>08</sup> / <sub>64</sub>	6.0-CS-SLEEVE-708-SP
6"	7- <sup>16</sup> / <sub>64</sub>	6.0-CS-SLEEVE-716-SP
6"	7- <sup>24</sup> / <sub>64</sub>	6.0-CS-SLEEVE-724-SP
8"	8- <sup>32</sup> / <sub>64</sub>	8.0-CS-SLEEVE-832-SP
8"	8- <sup>48</sup> / <sub>64</sub>	8.0-CS-SLEEVE-848-SP
8"	9	8.0-CS-SLEEVE-900-SP
8"	9- <sup>08</sup> / <sub>64</sub>	8.0-CS-SLEEVE-908-SP
8"	9- <sup>32</sup> / <sub>64</sub>	8.0-CS-SLEEVE-932-SP





## FLANGES



### FLOATING FLANGES

Hose Diameter	Part Number
2"	2.0-CS-FLANGE-SP
3"	3.0-CS-FLANGE-SP
4"	4.0-CS-FLANGE-SP
6"	6.0-CS-FLANGE-SP

### FIXED FLANGES

Hose Diameter	Part Number
2"	2.0-CS-FX-CRIMP-SP
3"	3.0-CS-FX-CRIMP-SP
4"	4.0-CS-FX-CRIMP-SP
6"	6.0-CS-FX-CRIMP-SP

### TURNBACKS

Hose Diameter	Part Number
2"	2.0-CS-TURNBACK-SP
3"	3.0-CS-TURNBACK-SP
4"	4.0-CS-TURNBACK-SP
6"	6.0-CS-TURNBACK-SP

## MALE ADAPTERS

SPOOL ADAPTER (MALE X MALE)



Hose Diameter	Part Number
2"	2.0-AA-ALUM-SP
2"	2.0-AA-SS-SP
3"	3.0-AA-ALUM-SP
4"	4.0-AA-ALUM-SP





## FEMALE ADAPTERS

DOUBLE FEMALE ADAPTER (FEMALE X FEMALE)



Hose Diameter	Part Number
2"	2.0-DD-ALUM-SP
2"	2.0-DD-SS-SP
3"	3.0-DD-ALUM-SP
4"	4.0-DD-ALUM-SP



## REDUCING ADAPTERS

COUPLER X ADAPTER - REDUCING (FEMALE X MALE)



Hose Diameter	Part Number
3" X 2"	3020-DA-AL-SP
3" X 2"	3020-DA-SS-SP
4" X 3"	4030-DA-AL-SP
6" X 4"	6040-DA-AL-SP



# BLAST FITTING

SANDBLAST COUPLING



Hose Diameter	Part Number
¾"	.75-Q1-ALUM
1"	1.0-Q2-ALUM
1-¼"	1.25-Q3-ALUM
1-½"	1.50-Q4-ALUM



# UNIVERSAL

UNIVERSAL CROWFOOT



Hose Diameter	Part Number
¾"	.75-CROW
1"	1.0-CROW



## METRIC CONVERSION CHART AND TABLE

### LENGTH

1 centimeter (cm)	=	10 millimeters (mm)
1 inch	=	2.54 centimeters (cm)
1 foot	=	0.3048 meters (m)
1 foot	=	12 inches
1 yard	=	3 feet
1 meter (m)	=	100 centimeters (cm)
1 meter (m)	=	3.280 feet
1 furlong	=	660 feet
1 kilometer (km)	=	1,000 meters (m)
1 kilometer (km)	=	0.621 miles
1 mile	=	5280 ft
1 mile	=	1.609 kilometers (km)
1 nautical mile	=	1.852 kilometers (km)

### AREA

1 square foot	=	144 square inches
1 square foot	=	929.030 square centimeters
1 square yard	=	9 square feet
1 square meter	=	10.763 square feet
1 acre	=	43,560 square feet
1 hectare	=	10,000 square meters
1 hectare	=	2.471 acres
1 square kilometer	=	100 hectares
1 square mile	=	2.589 square kilometers
1 square mile	=	640 acres

### SPEED

1 mile per hour	=	1.466 feet per second
1 mile per hour	=	1.609 kilometers per hour
1 knot	=	1.150 miles per hour
1 foot per second	=	0.681 miles per hour
1 kilometer per hour	=	0.621 miles per hour

### VOLUME

1 US tablespoon	=	3 US teaspoons
1 US fluid ounce	=	29.573 milliliters (ml)
1 US cup	=	16 US tablespoons
1 US cup	=	8 US fluid ounces
1 US pint	=	2 US cups
1 US pint	=	16 US fluid ounces
1 liter (l)	=	33.814 US fluid ounces
1 liter (l)	=	1000 milliliters (ml)
1 US quart	=	2 US pints
1 US gallon	=	4 US quarts
1 US gallon	=	3.78541178 liters

### WEIGHT

1 milligram (mg)	=	0.001 grams (g)
1 gram (g)	=	0.001 kilograms (kg)
1 gram (g)	=	0.035 ounces
1 ounce	=	28.349 grams (g)
1 ounce	=	0.0625 pounds
1 pound (lb)	=	16 ounces
1 pound (lb)	=	0.453 kilograms (kg)
1 kilogram (kg)	=	1,000 grams
1 kilogram (kg)	=	35.273 ounces
1 kilogram (kg)	=	2.204 pounds (lb)
1 stone	=	14 pounds
1 short ton	=	2,000 pounds
1 metric ton	=	1,000 kilograms (kg)

### TEMPERATURE

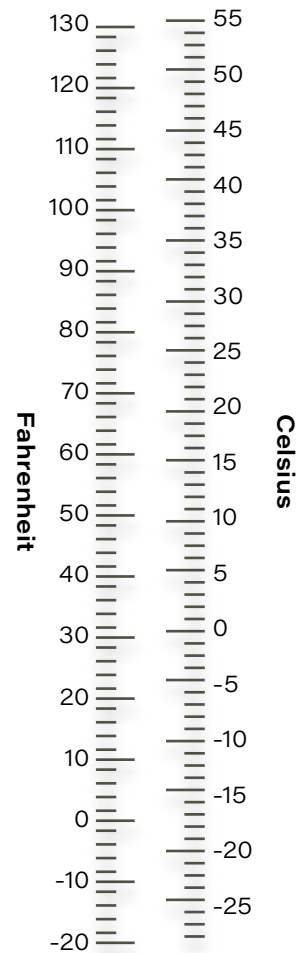

Texcel recommends using the following S.T.A.M.P.E.D. guide to determine the correct hose, coupling and attachment method for your intended application

<b>SIZE</b>	Hose length, fittings included (OAL):
	I.D.:
	O.D.:
<b>TEMPERATURE</b>	Hose tolerance:
	Minimum temperature of material going through the hose:
	Maximum temperature of material going through the hose:
	Minimum environmental temperature:
<b>APPLICATION</b>	Maximum environmental temperature:
	Indoor or outdoor use:
	Exceptional flexibility required? (Yes/No):
	Exposure to factors such as extreme ozone, heat, oil, abrasive materials, acid or other corrosive chemicals? (Yes/No):
	Food Grade quality? (Yes/No):
<b>MATERIALS</b>	Other:
	Solid? Specify:
	Liquid? Specify:
	Gas? Specify:
<b>PRESSURE</b>	Chemical? Specify:
	Vacuum requirements? (Yes/No):
	Working pressure of hose:
<b>ENDS</b>	Spikes in pressure:
	Style and material:
	Size:
	Threads/bolt hole alignment:
<b>DELIVERY</b>	Attachment methods:
	Capped? (Yes/No):
	Date required:
	Quantity needed:
	Testing Required? (Yes/No) If yes, then type:
Certification Required? (Yes/No) If yes, then type:	



## S.T.A.M.P.E.D



## LOCATIONS

### Contact Information

Toll Free: 800.231.7116  
Fax: 800.759.4673  
[sales@texcelrubber.com](mailto:sales@texcelrubber.com)

### Corporate Headquarters

4444 Homestead Road  
Houston, Texas 77028  
Phone: 713.675.8590

## ADDITIONAL LOCATIONS

### Chicago

2725 Davey Road, Suite 400  
Woodridge, Illinois 60517

### Birmingham

236 Distribution Drive  
Homewood, Alabama 35209

### Newark

211 Executive Drive, Suite 9  
Newark, Delaware 19702

### Denver

2460 Airport Blvd., Suite 300  
Aurora, Colorado 80011

## TRADE ASSOCIATIONS

We feel that it's important to stay up-to-date on the latest news and events within the industry, as well as maintain memberships in leading industry organizations. As a result, we are honored to be a part of the following organizations, which represent the same values and standards that are so important to us here at Texcel.



## MAKING A DIFFERENCE FOR YOUR BUSINESS

Supplying you with the right product when you need it.

All our product catalogs are available for download at [texcelrubber.com](http://texcelrubber.com) or you can request a catalog by calling 800.231.7116 or by emailing [sales@texcelrubber.com](mailto:sales@texcelrubber.com)



# Ask Us About Our Other Great Products



HYDRAULIC HOSE  
FITTINGS  
CRIMPERS



INDUSTRIAL HOSE  
COUPLINGS  
ASSEMBLIES



SHEET RUBBER  
SKIRTBOARD  
CHANNEL RUBBER



Ahead Of The Curve.

Founding Member



800.231.7116 ▪ [sales@texcelrubber.com](mailto:sales@texcelrubber.com) | Houston ▪ Chicago ▪ Delaware ▪ Denver ▪ Birmingham